

GE Fastrac Program Service Safety Switches

The GE Fastrac Program includes popular heavy duty and general duty safety switches.

Standard cycle: 5 days

GE Fastrac Program: Distributor stock

For more information on these products, order publications from Section 24.

Note:

EverGold™ Solar Duty Disconnects can be found in Section 22.

Quick Selection Guide, Enclosure Types.....	2-2
General Duty, Type TG.....	2-5
Heavy Duty, Type TH.....	2-7
Mill Duty, Type TH.....	2-14
Double Throw Switches, Type TC, TDT.....	2-17
Special Purpose, Heavy Duty, Type TH.....	2-20
Definite Purpose	2-22
AC Disconnects	2-23
Accessories: NEMA Type 1 and 3R Enclosures.....	2-24
Accessories: NEMA Type 4/4X and Mill Duty Enclosures	2-26
Additional Accessories	2-28
Enclosure and Knockout Dimensions	2-30 through 2-38
Low Voltage Construction Fuses	2-39



General Duty Safety Switch, Single-throw

Max. System Voltage	Ampere Rating	Switch Type	UL Listed Fusing		Enclosure Type	BuyLog Page
			Class	Withstanding Rating (rms Sym Amps)		
250Vac 250Vdc	30-200	Fusible	K	10,000	1 3R	2-5, 2-6
			H	10,000		
			R	100,000		
			K	10,000		
			H	10,000		
			R	10,000		
	400-600	No ¹ Fuse	K	10,000		
			H	10,000		
			R	100,000		
			K	10,000		
			H	10,000		
			R	10,000		



TG3321

Heavy Duty Safety Switch, Single-throw

Max. System Voltage	Ampere Rating	Switch Type	UL Listed Fusing		Enclosure Type	BuyLog Page
			Class	Withstanding Rating (rms Sym Amps)		
600Vac 250Vac	30-1200	Fusible	H	10,000	1 3R 4/4X 5,12 Mill Duty	2-7 through 2-16
			R	200,000 ⁴		
			J	200,000 ⁴		
			L ³	100,000		
			H	10,000		
			R	10,000		
		No ¹ Fuse	J	10,000		
			L ³	10,000		



TH3361SS

Double-throw Safety Switch

Max. System Voltage	Ampere Rating	Switch Type	UL Listed Fusing		Enclosure Type	BuyLog Page
			Class	Withstanding Rating (rms Sym Amps)		
600Vac 250Vdc	30-600	No Fuse	—	10,000	1 ² 3R	2-17 through 2-19

¹Non-fusible switch withstand ratings apply when protected by corresponding listed fuse type.

²100-200 amp also available as Type 3R (General Duty only).

³Class L fuses are only applicable when used with 800 and 1200A Type TC safety switches.

⁴Unless otherwise noted.



TC10323R



Enclosure Types

Type 1—Enclosures constructed for indoor use to provide a degree of protection to personnel against incidental contact with the enclosed equipment and to provide a degree of protection against falling dirt.

Type 3R—Enclosures constructed for either indoor or outdoor use to provide a degree of protection to personnel against incidental contact with the enclosed equipment; to provide a degree of protection against falling dirt, rain, sleet, and snow; and that will be undamaged by the external formation of ice on the enclosure

Type 4—Enclosures constructed for either indoor or outdoor use to provide a degree of protection to personnel against incidental contact with the enclosed equipment; to provide a degree of protection against falling dirt, rain, sleet, snow, windblown dust, splashing water, and hose-directed water; and that will be undamaged by the external formation of ice on the enclosure.

Type 4X—Enclosures constructed for either indoor or outdoor use to provide a degree of protection to personnel against incidental contact with the enclosed equipment; to provide a degree of protection against falling dirt, rain, sleet, snow, windblown dust, splashing water, hose-directed water, and corrosion; and that will be undamaged by the external formation of ice on the enclosure.

Type 5—Enclosures constructed for indoor use to provide a degree of protection to personnel against incidental contact with the enclosed equipment; to provide a degree of protection against falling dirt; against settling airborne dust, lint, fibers, and flyings; and to provide a degree of protection against dripping and light splashing of liquids

Type 12—Enclosures constructed (without knockouts) for indoor use to provide a degree of protection to personnel against incidental contact with the enclosed equipment; to provide a degree of protection against falling dirt; against circulating dust, lint, fibers, and flyings; and to provide a degree of protection against dripping and light splashing of liquids

Application Note: For applications of disconnecting means in motor circuit applications, disconnect must be sized based on ampacity per NEC 430-110, but not less than 115% of Motor Name-Plate current.

Comparison of Specific Applications of Enclosures for Indoor Nonhazardous Locations

Provides a Degree of Protection Against the Following Environmental Conditions	Type of Enclosure				
	1*	4	4X	5	12
Incidental contact with the enclosed equipment	X	X	X	X	X
Falling dirt	X	X	X	X	X
Falling liquids and light splashing	-	X	X	X	X
Circulating dust, lint, fibers, and flyings**	-	X	X	-	X
Settling airborne dust, lint, fibers, and flyings**	-	X	X	X	X
Hosedown and splashing water	-	X	X	-	-
Oil and coolant seepage	-	-	-	-	X
Corrosive agents	-	-	X	-	-

*These enclosures may be ventilated.

** These fibers and flyings are nonhazardous materials and are not considered Class III type ignitable fibers or combustible flyings. For Class III type ignitable fibers or combustible flyings see the National Electrical Code, Article 500.

Applications of Enclosures for Outdoor Nonhazardous Locations

Provides a Degree of Protection Against the Following Environmental Conditions	Type of Enclosure		
	3R*	4	4X
Incidental contact with the enclosed equipment	X	X	X
Rain, snow, and sleet**	X	X	X
Windblown dust, lint, fibers, and flyings	-	X	X
Hosedown	-	X	X
Corrosive agents	-	-	X

* These enclosures may be ventilated.

** External operating mechanisms are not required to be operable when the enclosure is ice covered.



Safety Switches

Spec-Setter™ Safety Switches

Quick Selection Guide

Product Number Structure

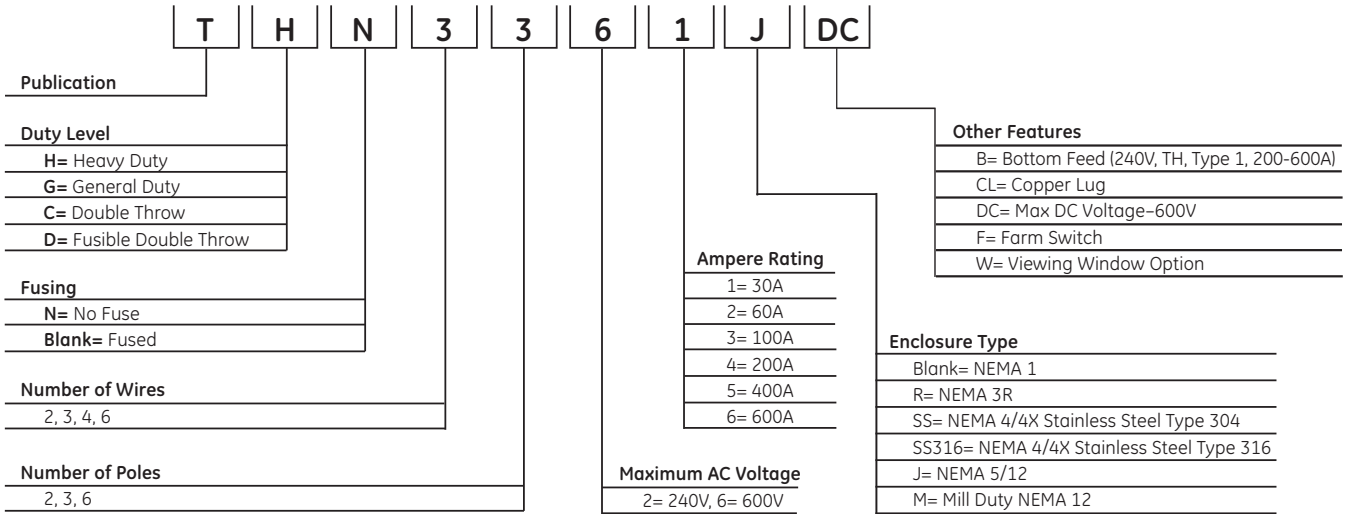

Note: This information is provided for interpreting product numbers. It should not be used to build product numbers.



Safety Switches General Duty, Type TG

Spec-Setter™ Safety Switches

30-600 Amperes

240 Volts AC

250 Volts DC

Page Updated 09 / 2011

Section 2

Cartridge Fuse, Type TG Switches

- Designed for residential or light commercial application where duty is not severe.
- UL Listed. Products in this section have been tested by UL and shown to meet the construction and performance requirements of UL Standard Number 98, Enclosed and Dead Front Switches.
- Meet or exceed NEMA Enclosed Switch Standard KS1 for Type GD.
- CSA certified.
- 60°C and 75°C conductor rating.
- Feature quick-make, quick-break mechanisms (30-200 amps).
- Suitable for use as service entrance equipment when installed in accordance with National Electrical Code.
- 30-200 amp fusible switches are rated 100,000 rms amps, sym IC when used with Class R fuses.
- Order appropriate Class R Fusing Kit from pages 2-28 and 2-29.
- Bottom-feed version available for 200-600 amp, NEMA 1 only.

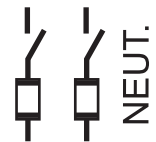

Fusible, Two-pole, 120/240 and 240 Volts AC; 250 Volts DC (30-100 amps only); Three-wire SN, 240 Volts AC

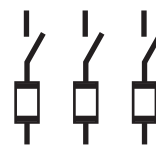

Fusible, Three-pole, 240 Volts AC

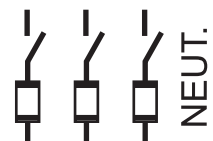

Fusible, Four-wire SN, 208/120 and 240 Volts AC

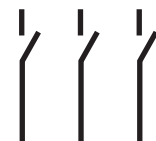

No Fuse, Two-pole, 240 Volts AC; 250 Volts DC (30-100 amps only);
Three-pole, 240 Volts AC or Two-pole with Switching Neutral



Safety Switches General Duty, Type TG

Spec-Setter™ Safety Switches

30-600 Amperes

240 Volts AC

250 Volts DC

Section 2

Page Updated 09 / 2011

Fusible, Two-pole, 120/240 and 240 Volts AC; 250 Volts DC (30-100 amps only); Three-wire SN, 240 Volts AC

Ampere Rating	Enclosure Type	HP, 240 Vac, NEC Std, 1-ph	HP, 240 Vac, NEC Std, 3-ph	HP, 240 Vac, Time Delay, 1-ph	HP, 240 Vac, Time Delay, 3-ph	HP, 125 Vdc	HP, 250 Vdc	Product Number	List Price GO-131A
30A	NEMA Type 1	1 1/2	3	3	7 1/2	2	5	TG3221 ¹	\$77.00
60A	NEMA Type 1	3	7 1/2	10	15	3	10	TG3222	\$135.00
100A	NEMA Type 1	7 1/2	15	15	30	-	20	TG3223	\$277.00
200A	NEMA Type 1	15	25	15	50	-	-	TG3224	\$579.00
400A	NEMA Type 1	-	50	-	100	-	-	TG3225	\$1628.00
600A	NEMA Type 1	-	75	-	100	-	-	TG3226	\$3253.00
30A	NEMA Type 3R	1 1/2	3	3	7 1/2	2	5	TG3221R	\$124.00
60A	NEMA Type 3R	3	7 1/2	10	15	3	10	TG3222R	\$213.00
100A	NEMA Type 3R	7 1/2	15	15	30	-	20	TG3223R	\$313.00
200A	NEMA Type 3R	15	25	15	50	-	-	TG3224R	\$779.00
400A	NEMA Type 3R	-	50	-	100	-	-	TG3225R	\$2197.00
600A	NEMA Type 3R	-	75	-	100	-	-	TG3226R	\$4167.00

Fusible, Three-pole, 240 Volts AC; 250 Volts DC (30-100 amps only)

Ampere Rating	Enclosure Type	HP, 240 Vac, NEC Std, 1-ph	HP, 240 Vac, NEC Std, 3-ph	HP, 240 Vac, Time Delay, 1-ph	HP, 240 Vac, Time Delay, 3-ph	HP, 125 Vdc	HP, 250 Vdc	Product Number	List Price GO-131A
30A	NEMA Type 1	1 1/2	3	3	7 1/2	-	5	TG4321 ¹	\$126.00
60A	NEMA Type 1	3	7 1/2	10	15	3	10	TG4322	\$213.00
100A	NEMA Type 1	7 1/2	15	15	30	-	20	TG4323	\$366.00
200A	NEMA Type 1	15	25	15	50	-	-	TG4324	\$788.00
400A	NEMA Type 1	-	50	-	100	-	-	TG3325	\$1737.00
600A	NEMA Type 1	-	75	-	100	-	-	TG3326	\$3482.00
30A	NEMA Type 3R	1 1/2	3	3	7 1/2	-	5	TG4321R	\$193.00
60A	NEMA Type 3R	3	7 1/2	10	15	3	10	TG4322R	\$286.00
100A	NEMA Type 3R	7 1/2	15	15	30	-	20	TG4323R	\$527.00
200A	NEMA Type 3R	15	25	15	50	-	-	TG4324R	\$957.00
400A	NEMA Type 3R	-	50	-	100	-	-	TG3325R	\$2251.00
600A	NEMA Type 3R	-	75	-	100	-	-	TG3326R	\$4857.00

Fusible, Four-wire SN, 208/120 and 240 Volts AC

Ampere Rating	Enclosure Type	HP, 240 Vac, NEC Std, 1-ph	HP, 240 Vac, NEC Std, 3-ph	HP, 240 Vac, Time Delay, 1-ph	HP, 240 Vac, Time Delay, 3-ph	HP, 125 Vdc	HP, 250 Vdc	Product Number	List Price GO-131A
30A	NEMA Type 1	1 1/2	3	3	7 1/2	-	5	TG4321 ¹	\$126.00
60A	NEMA Type 1	3	7 1/2	10	15	3	10	TG4322	\$213.00
100A	NEMA Type 1	7 1/2	15	15	30	-	20	TG4323	\$366.00
200A	NEMA Type 1	15	25	15	50	-	-	TG4324	\$788.00
400A	NEMA Type 1	-	50	-	100	-	-	TG4325	\$1985.00
600A	NEMA Type 1	-	75	-	100	-	-	TG4326	\$3704.00
30A	NEMA Type 3R	1 1/2	3	3	7 1/2	-	5	TG4321R	\$193.00
60A	NEMA Type 3R	3	7 1/2	10	15	3	10	TG4322R	\$286.00
100A	NEMA Type 3R	7 1/2	15	15	30	-	20	TG4323R	\$527.00
200A	NEMA Type 3R	15	25	15	50	-	-	TG4324R	\$957.00
400A	NEMA Type 3R	-	50	-	100	-	-	TG3325R ²	\$2251.00
								TN165	\$232.00
600A	NEMA Type 3R	-	75	-	100	-	-	TG3326R ²	\$4857.00
								TN166	\$232.00

No Fuse, Two-pole⁴, 240 Volts AC; 250 Volts DC (30-100 amps only); Three-pole, 240 Volts AC or Two-pole with Switching Neutral

Ampere Rating	Enclosure Type	HP, 240 Vac, NEC Std, 1-ph	HP, 240 Vac, NEC Std, 3-ph	HP, 240 Vac, Time Delay, 1-ph	HP, 240 Vac, Time Delay, 3-ph	HP, 125 Vdc	HP, 250 Vdc	Product Number	List Price GO-131A
30A	NEMA Type 1	3	7 1/2	3	7 1/2	-	5	TGN3321 ¹	\$102.00
60A	NEMA Type 1	10	15	10	15	3	10	TGN3322 ³	\$135.00
100A	NEMA Type 1	15	30	15	30	-	20	TGN3323 ³	\$313.00
200A	NEMA Type 1	15	50	15	50	-	-	TGN3324	\$579.00
400A	NEMA Type 1	-	100	-	100	-	-	TGN3325	\$1397.00
600A	NEMA Type 1	-	100	-	100	-	-	TGN3326	\$2667.00
30A	NEMA Type 3R	3	7 1/2	3	7 1/2	-	5	TGN3321R	\$193.00
60A	NEMA Type 3R	10	15	10	15	3	10	TGN3322R ³	\$286.00
100A	NEMA Type 3R	15	30	15	30	-	20	TGN3323R ³	\$527.00
200A	NEMA Type 3R	15	50	15	50	-	-	TGN3324R	\$957.00

For Type 1 Enclosure: 200-600 amp devices available factory reversed for bottom feed. Add "B" suffix to product number (e.g., TG3224B). List Price adder \$44.00, GO-131A. UL Listed.

For Type 3R Enclosure: 30-200 amp devices have removable closing cap. Order hubs for these devices separately on page 2-29. Larger amp devices require field cut openings and customer-supplied hub.

NEMA Type 3R No Fuse versions, 400-600 ampere rating, available in heavy duty, type TH models.

¹Packaged five per carton.

²For 4 wire applications order neutral kit separately. See page 2-24.

³Not suitable for use as service equipment. Solid neutral not available.

⁴Use three-pole switch for two-pole application.



Safety Switches Heavy Duty, Type TH

Spec-Setter™ Safety Switches
30-1200 Amperes
240 Volts AC
250 Volts DC

Cartridge Fuse, Type TH Switches

- Designed for applications where safety, high performance and continuity of service are required.
- UL Listed. Products in this section have been tested by UL and shown to meet the construction and performance requirements of UL Standard Number 98, Enclosed and Dead Front Switches.
- CSA Certified.
- Meet Federal Specification WS-865C for heavy duty switches.
- Meet major automotive manufacturer's and JIC electrical specifications.
- Meet NEMA Enclosed Safety Switch Standard KS1 for Type HD.
- Full cover interlocks.
- 60°C and 75°C conductor ratings.
- Quick-make, quick-break mechanisms.
- Suitable for use as service entrance equipment when installed in accordance with the National Electrical Code.
- UL Listed ratings for fusible switches when used with these fuses:
 - Class H (10,000 rms amps, sym IC). Standard on 30-600 amps.
 - Class L (100,000 rms amps, sym IC). Only applicable when used with 800 and 1200 amp Type TC Safety Switches (e.g. TC72367)
 - Class J (200,000 rms amps, sym IC). See page 2-28 for field conversion details.
 - Class R (200,000 rms amps, sym IC). Order appropriate Class R fusing kit from page 2-28.
- Safety switch product numbers with suffix "SS" are grade 304 stainless steel. Product numbers with suffix "SS316" are grade 316 stainless steel.

Type TH Interrupting and Withstandability Ratings

Ampere Rating	Interrupting Rating Amps ¹ Symmetrical 600 volts AC, 3-phase	Fuse Clearing ² (I ² t x 10 ³)
30A	360	50
60A	1200	200
100A	1200	500
200A	3,400	2,000
400A	10,000	6,000
600A	10,000	12,000

¹Maximum current at rated voltage that switch will interrupt three times without assistance from an external device.

²Peak let-through energy for withstandability and circuit closing tests.



Fusible, Two-pole,
240 Volts AC; 250 Volts DC
and Two-pole,
600 Volts DC, Fusible
(2 poles in series for 600 Vdc)

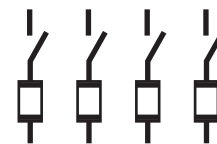

Four-pole, 480 and 600 Volts
AC, Fusible

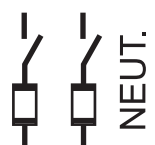

Fusible, Three-wire SN,
120/240 and 240 Volts AC

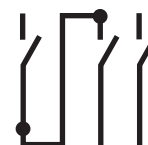

Two-pole, 600 Volts DC,
No Fuse

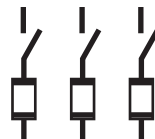

Fusible, Three-pole, 240 Volts
AC and Three-pole,
480, 480Y/277 and 600 Volts
AC-250 Volts DC, Fusible



Three-pole, 480 and
600 Volts AC-250 Volts DC or
Two-pole with Switching
Neutral, No Fuse

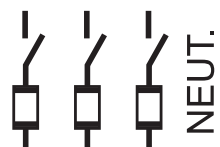

Fusible, Four-wire SN,
208/120 and 240 Volts AC



Four-pole, 480 and
600 Volts AC, No Fuse



Safety Switches Heavy Duty, Type TH

Spec-Setter™ Safety Switches

30-1200 Amperes

240 Volts AC

250 Volts DC

Section 2

Page Updated 09 / 2011

Fusible, Two-pole, 240 Volts AC; 250 Volts DC

Ampere Rating	Enclosure Type	HP, 240 Vac, NEC Std, 1-ph	HP, 240 Vac, NEC Std, 3-ph	HP, 240 Vac, Time Delay, 1-ph	HP, 240 Vac, Time Delay, 3-ph	HP, 125 Vdc	HP, 250 Vdc	Product Number	List Price GO-131
30A	NEMA Type 1	1 1/2	3	3	7 1/2	-	5	TH3221	\$153.00
60A	NEMA Type 1	3	7 1/2	10	15	5	10	TH3222	\$300.00
100A	NEMA Type 1	7 1/2	15	15	30	-	20	TH3223	\$467.00
200A	NEMA Type 1	15	25	-	60	-	40	TH3224	\$830.00
400A	NEMA Type 1	-	50	-	125	-	50	TH3225	\$1948.00
600A	NEMA Type 1	-	75	-	200	-	-	TH3226	\$3670.00
800A	NEMA Type 1	-	-	-	-	-	-	TC72267 ¹	\$6996.00
1200A	NEMA Type 1	-	-	-	-	-	-	TC72268 ¹	\$9614.00
30A	NEMA Type 3R	1 1/2	3	3	7 1/2	-	5	TH3221R	\$291.00
60A	NEMA Type 3R	3	7 1/2	10	15	5	10	TH3222R	\$542.00
100A	NEMA Type 3R	7 1/2	15	15	30	-	20	TH3223R	\$702.00
200A	NEMA Type 3R	15	25	-	60	-	40	TH3224R	\$1006.00
400A	NEMA Type 3R	-	50	-	125	-	50	TH3225R	\$2450.00
600A	NEMA Type 3R	-	75	-	200	-	50	TH3226R	\$4590.00
800A	NEMA Type 3R	-	-	-	-	-	-	TC72267R ^{1,2}	\$8975.00
1200A	NEMA Type 3R	-	-	-	-	-	-	TC72268R ^{1,2}	\$13127.00
30A	NEMA Type 4/4X	1 1/2	3	3	7 1/2	-	5	TH2221SS ⁴	\$1218.00
60A	NEMA Type 4/4X	3	7 1/2	10	15	5	10	TH2222SS ⁴	\$1463.00
100A	NEMA Type 4/4X	7 1/2	15	15	30	-	20	TH3223SS ⁴	\$3309.00
200A	NEMA Type 4/4X	15	25	-	60	-	40	TH3224SS ⁴	\$4538.00
400A	NEMA Type 4/4X	-	50	-	125	-	50	TH3225SS	\$9114.00
600A	NEMA Type 4/4X	-	75	-	200	-	50	TH3226SS	\$13008.00
30A	NEMA Type 5, 12	1 1/2	3	3	7 1/2	-	5	TH2221J	\$295.00
60A	NEMA Type 5, 12	3	7 1/2	10	15	5	10	TH2222J	\$398.00
100A	NEMA Type 5, 12	7 1/2	15	15	30	-	20	TH3223J	\$678.00
200A	NEMA Type 5, 12	15	25	-	60	-	40	TH3224J	\$1058.00
400A	NEMA Type 5, 12	-	50	-	125	-	50	TH3225J	\$2623.00
600A	NEMA Type 5, 12	-	75	-	200	-	50	TH3226J	\$4281.00

Fusible, Three-wire SN, 120/240 and 240 Volts AC; 250 Volts DC (30-600 amps)

Ampere Rating	Enclosure Type	HP, 240 Vac, NEC Std, 1-ph	HP, 240 Vac, NEC Std, 3-ph	HP, 240 Vac, Time Delay, 1-ph	HP, 240 Vac, Time Delay, 3-ph	HP, 125 Vdc	HP, 250 Vdc	Product Number	List Price GO-131
30A	NEMA Type 1	1 1/2	3	3	7 1/2	-	5	TH3221	\$153.00
60A	NEMA Type 1	3	7 1/2	10	15	5	10	TH3222	\$300.00
100A	NEMA Type 1	7 1/2	15	15	30	-	20	TH3223	\$467.00
200A	NEMA Type 1	15	25	-	60	-	40	TH3224	\$830.00
400A	NEMA Type 1	-	50	-	125	-	50	TH3225	\$1948.00
600A	NEMA Type 1	-	75	-	200	-	50	TH3226	\$3670.00
800A	NEMA Type 1	-	-	-	-	-	-	TC72267 ^{1,3}	\$6996.00
								TN167	\$490.00
1200A	NEMA Type 1	-	-	-	-	-	-	TC72268 ^{1,3}	\$9614.00
								TN168A	\$675.00
30A	NEMA Type 3R	1 1/2	3	3	7 1/2	-	5	TH3221R	\$291.00
60A	NEMA Type 3R	3	7 1/2	10	15	5	10	TH3222R	\$542.00
100A	NEMA Type 3R	7 1/2	15	15	30	-	20	TH3223R	\$702.00
200A	NEMA Type 3R	15	25	-	60	-	40	TH3224R	\$1006.00
400A	NEMA Type 3R	-	50	-	125	-	50	TH3225R	\$2450.00
600A	NEMA Type 3R	-	75	-	200	-	50	TH3226R	\$4590.00
800A	NEMA Type 3R	-	-	-	-	-	-	TC72267R ^{1,2,3}	\$8975.00
								TN167	\$490.00
1200A	NEMA Type 3R	-	-	-	-	-	-	TC72268R ^{1,2,3}	\$13127.00
								TN168A	\$675.00
30A	NEMA Type 4/4X	1 1/2	3	3	7 1/2	-	5	TH3221SS ⁴	\$1260.00
60A	NEMA Type 4/4X	3	7 1/2	10	15	5	10	TH3222SS ⁴	\$1526.00
100A	NEMA Type 4/4X	7 1/2	15	15	30	-	20	TH3223SS ⁴	\$3309.00
200A	NEMA Type 4/4X	15	25	-	60	-	40	TH3224SS ⁴	\$4538.00
400A	NEMA Type 4/4X	-	50	-	125	-	50	TH3225SS	\$9114.00
600A	NEMA Type 4/4X	-	75	-	200	-	50	TH3226SS	\$13008.00
30A	NEMA Type 5, 12	1 1/2	3	3	7 1/2	-	5	TH3221J	\$345.00
60A	NEMA Type 5, 12	3	7 1/2	10	15	5	10	TH3222J	\$462.00
100A	NEMA Type 5, 12	7 1/2	15	15	30	-	20	TH3223J	\$678.00
200A	NEMA Type 5, 12	15	25	-	60	-	40	TH3224J	\$1058.00
400A	NEMA Type 5, 12	-	50	-	125	-	50	TH3225J	\$2623.00
600A	NEMA Type 5, 12	-	75	-	200	-	50	TH3226J	\$4281.00

¹Rated 600 Vac only. Accepts Class L fuses only. Type TH electrical performance does not apply.

²Not CSA certified.

³Order switch and neutral separately.

⁴Available with "-BA" suffix for ARRA compliance. Same list price and GO schedule. Contact GE Sales Office for other ARRA compliant safety switches.



Safety Switches Heavy Duty, Type TH

Spec-Setter™ Safety Switches

30-1200 Amperes

240 Volts AC

250 Volts DC

Section 2

Page Updated 09 / 2011

Fusible, Three-pole, 240 Volts AC; 250 Volts DC (30-600 amps)

Ampere Rating	Enclosure Type	HP, 240 Vac, NEC Std, 1-ph	HP, 240 Vac, NEC Std, 3-ph	HP, 240 Vac, Time Delay, 1-ph	HP, 240 Vac, Time Delay, 3-ph	HP, 125 Vdc	HP, 250 Vdc	Product Number	List Price GO-131
30A	NEMA Type 1	1 1/2	3	3	7 1/2	-	5	TH4321	\$203.00
60A	NEMA Type 1	3	7 1/2	10	15	5	10	TH4322	\$344.00
100A	NEMA Type 1	7 1/2	15	15	30	-	20	TH4323	\$542.00
200A	NEMA Type 1	15	25	-	60	-	40	TH4324	\$932.00
400A	NEMA Type 1	-	50	-	125	-	50	TH3325	\$2157.00
600A	NEMA Type 1	-	75	-	200	-	50	TH3326	\$3889.00
800A	NEMA Type 1	-	-	-	-	-	-	TC72367 ¹	\$9661.00
1200A	NEMA Type 1	-	-	-	-	-	-	TC72368 ¹	\$12688.00
30A	NEMA Type 3R	1 1/2	3	3	7 1/2	-	5	TH4321R	\$364.00
60A	NEMA Type 3R	3	7 1/2	10	15	5	10	TH4322R	\$573.00
100A	NEMA Type 3R	7 1/2	15	15	30	-	20	TH4323R	\$821.00
200A	NEMA Type 3R	15	25	-	60	-	40	TH4324R	\$1130.00
400A	NEMA Type 3R	-	50	-	125	-	50	TH3325R	\$2501.00
600A	NEMA Type 3R	-	75	-	200	-	50	TH3326R	\$5235.00
800A	NEMA Type 3R	-	-	-	-	-	-	TC72367R ^{1,2}	\$11966.00
1200A	NEMA Type 3R	-	-	-	-	-	-	TC72368R ^{1,2}	\$15546.00
30A	NEMA Type 4/4X	1 1/2	3	3	7 1/2	-	5	TH3321SS ⁴	\$1294.00
60A	NEMA Type 4/4X	3	7 1/2	10	15	5	10	TH3322SS ⁴	\$1597.00
100A	NEMA Type 4/4X	7 1/2	15	15	30	-	20	TH4323SS ⁴	\$3380.00
200A	NEMA Type 4/4X	15	25	-	60	-	40	TH4324SS ⁴	\$4733.00
400A	NEMA Type 4/4X	-	50	-	125	-	50	TH4325SS	\$9542.00
600A	NEMA Type 4/4X	-	75	-	200	-	50	TH4326SS	\$13570.00
30A	NEMA Type 5, 12	1 1/2	3	3	7 1/2	-	5	TH3321J	\$391.00
60A	NEMA Type 5, 12	3	7 1/2	10	15	5	10	TH3322J	\$551.00
100A	NEMA Type 5, 12	7 1/2	15	15	30	-	20	TH4323J	\$881.00
200A	NEMA Type 5, 12	15	25	-	60	-	40	TH4324J	\$1262.00
400A	NEMA Type 5, 12	-	50	-	125	-	50	TH4325J	\$2896.00
600A	NEMA Type 5, 12	-	75	-	200	-	50	TH4326J	\$4657.00

Fusible, Four-wire SN, 208/120 and 240 Volts AC; 250 Volts DC (30-600 amps)

Ampere Rating	Enclosure Type	HP, 240 Vac, NEC Std, 1-ph	HP, 240 Vac, NEC Std, 3-ph	HP, 240 Vac, Time Delay, 1-ph	HP, 240 Vac, Time Delay, 3-ph	HP, 125 Vdc	HP, 250 Vdc	Product Number	List Price GO-131
30A	NEMA Type 1	1 1/2	3	3	7 1/2	-	5	TH4321	\$203.00
60A	NEMA Type 1	3	7 1/2	10	15	5	10	TH4322	\$344.00
100A	NEMA Type 1	7 1/2	15	15	30	-	20	TH4323	\$542.00
200A	NEMA Type 1	15	25	-	60	-	40	TH4324	\$932.00
400A	NEMA Type 1	-	50	-	125	-	50	TH4325	\$2391.00
600A	NEMA Type 1	-	75	-	200	-	50	TH4326	\$4116.00
800A	NEMA Type 1	-	-	-	-	-	-	TC72367 ^{1,3}	\$9661.00
								TN167	\$490.00
1200A	NEMA Type 1	-	-	-	-	-	-	TC72368 ^{1,3}	\$12688.00
								TN168A	\$675.00
30A	NEMA Type 3R	1 1/2	3	3	7 1/2	-	5	TH4321R	\$364.00
60A	NEMA Type 3R	3	7 1/2	10	15	5	10	TH4322R	\$573.00
100A	NEMA Type 3R	7 1/2	15	15	30	-	20	TH4323R	\$821.00
200A	NEMA Type 3R	15	25	-	60	-	40	TH4324R	\$1130.00
400A	NEMA Type 3R	-	50	-	125	-	50	TH3325R	\$2501.00
600A	NEMA Type 3R	-	75	-	200	-	50	TH3326R	\$5235.00
800A	NEMA Type 3R	-	-	-	-	-	-	TC72367R ^{1,2,3}	\$11966.00
								TN167	\$490.00
1200A	NEMA Type 3R	-	-	-	-	-	-	TC72368R ^{1,2,3}	\$15546.00
								TN168A	\$675.00
30A	NEMA Type 4/4X	1 1/2	3	3	7 1/2	-	5	TH4321SS ⁴	\$1355.00
60A	NEMA Type 4/4X	3	7 1/2	10	15	5	10	TH4322SS ⁴	\$1654.00
100A	NEMA Type 4/4X	7 1/2	15	15	30	-	20	TH4323SS ⁴	\$3380.00
200A	NEMA Type 4/4X	15	25	-	60	-	40	TH4324SS ⁴	\$4733.00
400A	NEMA Type 4/4X	-	50	-	125	-	50	TH4325SS	\$9542.00
600A	NEMA Type 4/4X	-	75	-	200	-	50	TH4326SS	\$13570.00
30A	NEMA Type 5, 12	1 1/2	3	3	7 1/2	-	5	TH4321J	\$445.00
60A	NEMA Type 5, 12	3	7 1/2	10	15	5	10	TH4322J	\$599.00
100A	NEMA Type 5, 12	7 1/2	15	15	30	-	20	TH4323J	\$881.00
200A	NEMA Type 5, 12	15	25	-	60	-	40	TH4324J	\$1262.00
400A	NEMA Type 5, 12	-	50	-	125	-	50	TH4325J	\$2896.00
600A	NEMA Type 5, 12	-	75	-	200	-	50	TH4326J	\$4657.00

240 Volts - No fuse or Four-pole, 240 Volts AC, Use 600-Volt switches on page 2-10 through 2-13.

For Type 1 Enclosure: 200-600 amp devices available factory reversed for bottom feed. Add "B" suffix to product number (e.g., TH3224B) List Price Adder \$44.00, GO-131A.

UL Listed.

For Type 3R Enclosure: 30-200 amp devices have removable closing cap. Order hubs for these devices separately on page 2-29. Larger amp devices require field cut openings and customer-supplied hub.

¹Rated 600 Vac only. Accepts Class L fuses only. Type HD electrical performance does not apply.

²Not CSA certified.

³Order switch and neutral separately

⁴Available with "-BA" suffix for ARRA compliance. Same list price and GO schedule. Contact GE Sales Office for other ARRA compliant safety switches.



Safety Switches Heavy Duty, Type TH

Spec-Setter™ Safety Switches

30-1200 Amperes

240, 480, 600 Volts AC

600 Volts DC

Section 2

Two-pole 600 Volts DC, Fusible

Ampere Rating	Enclosure Type	HP, 480 Vac, NEC Std, 3-ph	HP, 600 Vac NEC Std, 3-ph	HP, 480 Vac Time Delay, 3-ph	HP, 600 Vac, Time Delay, 3-ph	HP, 125 Vdc	HP, 250 Vdc	HP, 600 Vdc	Product Number	List Price GO-131
30A	NEMA Type 1	-	-	-	-	-	-	15	TH2261DC	\$344.00
60A	NEMA Type 1	-	-	-	-	-	-	25	TH2262DC	\$417.00
100A	NEMA Type 1	-	-	-	-	-	-	25	TH2263DC	\$763.00
30A	NEMA Type 3R	-	-	-	-	-	-	15	TH2261RDC	\$579.00
60A	NEMA Type 3R	-	-	-	-	-	-	25	TH2262RDC	\$678.00
100A	NEMA Type 3R	-	-	-	-	-	-	25	TH2263RDC	\$1058.00
30A	NEMA Type 4/4X	-	-	-	-	-	-	15	TH2261SSDC	\$1578.00
60A	NEMA Type 4/4X	-	-	-	-	-	-	25	TH2262SSDC	\$1639.00
100A	NEMA Type 4/4X	-	-	-	-	-	-	25	TH2263SSDC	\$3473.00
30A	NEMA Type 5, 12	-	-	-	-	-	-	15	TH2261JDC	\$538.00
60A	NEMA Type 5, 12	-	-	-	-	-	-	25	TH2262JDC	\$563.00
100A	NEMA Type 5, 12	-	-	-	-	-	-	25	TH2263JDC	\$930.00

For Type 1 Enclosure: 200-600 amp devices available factory reversed for bottom feed. Add "B" suffix to product number (e.g., TH33365B). **List Price adder \$44.00, GO-131.**
UL Listed.

For Type 3R Enclosure: 30-200 amp devices have removable closing cap. Order hubs for these devices separately on page 2-29. Larger amp devices require field cut openings and **customer-supplied** hub.



Safety Switches Heavy Duty, Type TH

Spec-Setter™ Safety Switches

30-1200 Amperes

240, 480, 600 Volts AC

600 Volts DC

Page Updated 09 / 2011

Section 2



TH3361RF

Three-pole, 480, 480Y/277¹ and 600 Volts AC-250 DC, Fusible

Ampere Rating	Enclosure Type	HP, 480 Vac, NEC Std, 3-ph	HP, 600 Vac, NEC Std, 3-ph	HP, 480 Vac, Time Delay, 3-ph	HP, 600 Vac, Time Delay, 3-ph	HP, 125 Vdc	HP, 250 Vdc	HP, 600 Vdc	Product Number	List Price GO-131
30A	NEMA Type 1	5	7 1/2	15	20	-	5	-	TH3361	\$344.00
60A	NEMA Type 1	15	15	30	50	-	10	-	TH3362	\$417.00
100A	NEMA Type 1	25	30	60	75	-	20	-	TH3363	\$763.00
200A	NEMA Type 1	50	60	125	150	-	40	-	TH3364	\$1103.00
400A	NEMA Type 1	100	125	250	350	-	50	-	TH3365	\$2868.00
600A	NEMA Type 1	150	200	400	500	-	50	-	TH3366	\$4825.00
800A	NEMA Type 1	-	-	-	-	-	-	-	TC72367 ²	\$9661.00
1200A	NEMA Type 1	-	-	-	-	-	-	-	TC72368 ²	\$12688.00
30A	NEMA Type 3R	5	7 1/2	15	20	-	5	-	TH3361R	\$579.00
30A	NEMA Type 3R	5	7 1/2	15	20	-	5	-	TH3361RF ⁴	\$579.00
60A	NEMA Type 3R	15	15	30	50	-	10	-	TH3361RF2 ⁴	\$749.00
60A	NEMA Type 3R	15	15	30	50	-	10	-	TH3362R	\$678.00
60A	NEMA Type 3R	15	15	30	50	-	10	-	TH3362RF ⁴	\$678.00
100A	NEMA Type 3R	25	30	60	75	-	20	-	TH3363R	\$1058.00
200A	NEMA Type 3R	50	60	125	150	-	40	-	TH3364R ⁶	\$1461.00
400A	NEMA Type 3R	100	125	250	350	-	50	-	TH3365R	\$3414.00
600A	NEMA Type 3R	150	200	400	500	-	50	-	TH3366R	\$6738.00
800A	NEMA Type 3R	-	-	-	-	-	-	-	TC72367R ^{2,3}	\$11966.00
1200A	NEMA Type 3R	-	-	-	-	-	-	-	TC72368R ^{2,3}	\$15546.00
30A	NEMA Type 4/4X	5	7 1/2	15	20	-	5	-	TH3361SS ⁷	\$1577.00
60A	NEMA Type 4/4X	15	15	30	50	-	10	-	TH3362SS ⁷	\$1737.00
100A	NEMA Type 4/4X	25	30	60	75	-	20	-	TH3363SS ⁷	\$3461.00
200A	NEMA Type 4/4X	50	60	125	150	-	40	-	TH3364SS ^{6,7}	\$4849.00
400A	NEMA Type 4/4X	100	125	250	350	-	50	-	TH3365SS	\$9542.00
600A	NEMA Type 4/4X	150	200	400	500	-	50	-	TH3366SS	\$13570.00
30A	NEMA Type 5, 12	5	7 1/2	15	20	-	5	-	TH3361J	\$586.00
60A	NEMA Type 5, 12	15	15	30	50	-	10	-	TH3362J	\$602.00
100A	NEMA Type 5, 12	25	30	60	75	-	20	-	TH3363J	\$967.00
200A	NEMA Type 5, 12	50	60	125	150	-	40	-	TH3364J ⁶	\$1505.00
400A	NEMA Type 5, 12	100	125	250	350	-	50	-	TH3365J	\$3311.00
600A	NEMA Type 5, 12	150	200	400	500	-	50	-	TH3366J	\$5582.00
30A	NEMA Type 3R, 5, 12	5	7 1/2	15	20	-	5	-	TH3361JR	\$579.00
60A	NEMA Type 3R, 5, 12	15	15	30	50	-	10	-	TH3362JR	\$678.00
100A	NEMA Type 3R, 5, 12	25	30	60	75	-	20	-	TH3363JR	\$1058.00
200A	NEMA Type 3R, 5, 12	50	60	125	150	-	40	-	TH3364JR ⁶	\$1461.00
400A	NEMA Type 3R, 5, 12	100	125	250	350	-	50	-	TH3365JR	\$3414.00
600A	NEMA Type 3R, 5, 12	150	200	400	500	-	50	-	TH3366JR	\$6738.00

Four-pole, 480 and 600 Volts AC, Fusible⁵

Ampere Rating	Enclosure Type	HP, 480 Vac, NEC Std, 2-ph	HP, 600 Vac, NEC Std, 2-ph	HP, 480 Vac, Time Delay, 2-ph	HP, 600 Vac, Time Delay, 2-ph	HP, 125 Vdc	HP, 250 Vdc	HP, 600 Vdc	Product Number	List Price GO-131
30A	NEMA Type 1, 3R, 5, 12	7 1/2	10	20	25	-	5	-	TH6661	\$2303.00
60A	NEMA Type 1, 3R, 5, 12	15	20	40	50	-	10	-	TH6662	\$2762.00
100A	NEMA Type 1, 3R, 5, 12	20	30	50	50	-	20	-	TH6663	\$3358.00
200A	NEMA Type 1, 3R, 5, 12	50	50	-	-	-	40	-	TH6664	\$7555.00

For Type 1 Enclosure: 200-600 amp devices available factory reversed for bottom feed. Add "B" suffix to product number (e.g., TH33365B). List Price adder \$44.00, GO-131. UL Listed.

For Type 3R Enclosure: 30-200 amp devices have removable closing cap. Order hubs for these devices separately on page 2-29. Larger amp devices require field cut openings and customer-supplied hub.

¹Order neutral kits from pages 2-24 and 2-26.

²Rated 600 Vac only. Accepts Class L fuses only. Type HD electrical performance does not apply.

³Not CSA Certified

⁴Farm switch with oversize Type 3R enclosure and vertical hinge. See enclosure dimensions on page 2-31.

⁵Use four poles of six-pole

⁶Rated to maximum 100,000 ampere interrupting capacity.

⁷Available with "-BA" suffix for ARRA compliance. Same list price and GO schedule. Contact GE Sales Office for other ARRA compliant safety switches.



Safety Switches Heavy Duty, Type TH

Spec-Setter™ Safety Switches

30-1200 Amperes

240, 480, 600 Volts AC

600 Volts DC

Section 2

Page Updated 12 / 2011

Two-pole, 600 Volts DC, No Fuse

Ampere Rating	Enclosure Type	HP, 240 Vac, NEC Std, 1-ph	HP, 240 Vac, NEC Std, 3-ph	HP, 480 Vac, Time Delay, 3-ph	HP, 600 Vac, Time Delay, 3-ph	HP, 125 Vdc	HP, 250 Vdc	HP, 600 Vdc	Product Number	List Price GO-131
30A	NEMA Type 1	-	-	-	-	-	-	15	THN2261DC	\$179.00
60A	NEMA Type 1	-	-	-	-	-	-	25	THN2262DC	\$324.00
100A	NEMA Type 1	-	-	-	-	-	-	25	THN2263DC	\$510.00
30A	NEMA Type 3R	-	-	-	-	-	-	15	THN2261RDC	\$322.00
60A	NEMA Type 3R	-	-	-	-	-	-	25	THN2262RDC	\$564.00
100A	NEMA Type 3R	-	-	-	-	-	-	25	THN2263RDC	\$788.00
30A	NEMA Type 4/4X	-	-	-	-	-	-	15	THN2261SSDC	\$1300.00
60A	NEMA Type 4/4X	-	-	-	-	-	-	25	THN2262SSDC	\$1562.00
100A	NEMA Type 4/4X	-	-	-	-	-	-	25	THN2263SSDC	\$3216.00
30A	NEMA Type 5, 12	-	-	-	-	-	-	15	THN2261JDC	\$352.00
60A	NEMA Type 5, 12	-	-	-	-	-	-	25	THN2262JDC	\$397.00
100A	NEMA Type 5, 12	-	-	-	-	-	-	25	THN2263JDC	\$632.00

Three-pole, 480 and 600 Volts AC - 250 Volts DC or Two-pole with Switching Neutral, No Fuse

Ampere Rating	Enclosure Type	HP, 240 Vac, NEC Std, 1-ph	HP, 240 Vac, NEC Std, 3-ph	HP, 480 Vac, Time Delay, 3-ph	HP, 600 Vac, Time Delay, 3-ph	HP, 125 Vdc	HP, 250 Vdc	HP, 600 Vdc	Product Number	List Price GO-131
30A	NEMA Type 1	3	10	-	-	3	5	-	THN3321 ¹	\$171.00
30A	NEMA Type 1	3	10	20	30	3	5	-	THN3361	\$179.00
60A	NEMA Type 1	10	20	50	60	5	10	-	THN3362	\$324.00
100A	NEMA Type 1	20	40	75	100	-	20	-	THN3363	\$510.00
200A	NEMA Type 1	30	60	125	150	-	40	-	THN3364	\$775.00
400A	NEMA Type 1	-	125	250	350	-	50	-	THN3365	\$1736.00
600A	NEMA Type 1	-	200	400	500	-	50	-	THN3366	\$3092.00
800A	NEMA Type 1	-	-	-	-	-	-	-	TC36367 ^{2,3}	\$6302.00
1200A	NEMA Type 1	-	-	-	-	-	-	-	TC36368 ^{2,3}	\$8457.00
30A	NEMA Type 3R	3	10	20	30	3	5	-	THN3361R	\$322.00
30A	NEMA Type 3R	3	10	20	30	3	5	-	THN3361RF ⁴	\$436.00
60A	NEMA Type 3R	10	20	50	60	5	10	-	THN3362R	\$564.00
60A	NEMA Type 3R	10	20	50	60	5	10	-	THN3362RF ⁴	\$564.00
100A	NEMA Type 3R	20	40	75	100	-	20	-	THN3363R	\$788.00
200A	NEMA Type 3R	30	60	125	150	-	40	-	THN3364R	\$957.00
400A	NEMA Type 3R	-	125	250	350	-	50	-	THN3365R	\$2376.00
600A	NEMA Type 3R	-	200	400	500	-	50	-	THN3366R	\$4755.00
30A	NEMA Type 4/4X	3	10	20	30	3	5	-	THN3361SS ⁵	\$1326.00
60A	NEMA Type 4/4X	10	20	50	60	5	10	-	THN3362SS ⁵	\$1577.00
100A	NEMA Type 4/4X	20	40	75	100	-	20	-	THN3363SS ⁵	\$3217.00
200A	NEMA Type 4/4X	30	60	125	150	-	40	-	THN3364SS ⁵	\$4393.00
400A	NEMA Type 4/4X	-	125	250	350	-	50	-	THN3365SS	\$8899.00
600A	NEMA Type 4/4X	-	200	400	500	-	50	-	THN3366SS	\$11946.00
30A	NEMA Type 5, 12	3	10	20	30	3	5	-	THN3361J	\$412.00
60A	NEMA Type 5, 12	10	20	50	60	5	10	-	THN3362J	\$533.00
100A	NEMA Type 5, 12	20	40	75	100	-	20	-	THN3363J	\$758.00
200A	NEMA Type 5, 12	30	60	125	150	-	40	-	THN3364J	\$1008.00
400A	NEMA Type 5, 12	-	125	250	350	-	50	-	THN3365J	\$2497.00
600A	NEMA Type 5, 12	-	200	400	500	-	50	-	THN3366J	\$4065.00

For Type 1 Enclosure: 200-600 amp devices available factory reversed for bottom feed. Add "B" suffix to product number (e.g., TH33365B). List Price adder \$44.00, GO-131. UL Listed.

For Type 3R Enclosure: 30-200 amp devices have removable closing cap. Order hubs for these devices separately on page 2-29. Larger amp devices require field cut openings and customer-supplied hub.

Use molded case switch in circuit breaker enclosure.

¹Rated 250 Vac/dc only. Compact enclosure.

²Rated 600 Vac only. Accepts Class L fuses only. Type HD electrical performance does not apply.

³Neutral kit not available. Not suitable for use as service equipment. Order TC72XXX series product numbers and separate neutral kit as required.

⁴Farm switch with oversize Type 3R enclosure and vertical hinge. See enclosure dimensions on page 2-31.

⁵Available with "-BA" suffix for ARRA compliance. Same list price and GO schedule. Contact GE Sales Office for other ARRA compliant safety switches.



Safety Switches Heavy Duty, Type TH

Spec-Setter™ Safety Switches

30-1200 Amperes

240, 480, 600 Volts AC

600 Volts DC

Four-pole, 480 and 600 Volts AC, No Fuse^{2,3}

Ampere Rating	Enclosure Type	HP, 240 Vac, NEC Std, 1-ph	HP, 240 Vac, NEC Std, 2-ph	HP, 480 Vac, Time Delay, 2-ph	HP, 600 Vac, Time Delay, 2-ph	HP, 125 Vdc	HP, 250 Vdc	HP, 600 Vdc	Product Number	List Price GO-131
30A	NEMA Type 1, 3R, 5, 12	-	10	20	25	-	5	-	THN6661	\$2048.00
60A	NEMA Type 1, 3R, 5, 12	-	20	40	50	-	10	-	THN6662	\$2372.00
100A	NEMA Type 1, 3R, 5, 12	-	30	50	50	-	20	-	THN6663	\$2919.00
200A	NEMA Type 1, 3R, 5, 12	-	50	-	-	-	40	-	THN6664	\$6564.00

Heavy Duty Safety Switches with 316 Stainless Steel Type NEMA 4/4X, Water and Dust-tight

- More resistant to general corrosion and pitting/crevice corrosion than 304 stainless steel
- Higher creep, stress-to-rupture and tensile strength at elevated temperatures than 304 stainless steel
- Excellent resistance to reducing acids and similar media
- Standard lead time 2 weeks

Three-pole 240/600 Volts—Fusible, 316 Stainless Steel

Ampere Rating	Enclosure Type	System Voltage	Product Number	List Price GO-131
30A	NEMA Type 4/4X	600Vac	TH3361SS316 ⁴	\$2296.00
60A	NEMA Type 4/4X	600Vac	TH3362SS316 ⁴	\$2528.00
100A	NEMA Type 4/4X	600Vac	TH3363SS316 ⁴	\$5041.00
200A	NEMA Type 4/4X	600Vac	TH3364SS316 ^{4,5}	\$7061.00
400A	NEMA Type 4/4X	600Vac	TH3365SS316	\$13895.00
600A	NEMA Type 4/4X	600Vac	TH3366SS316	\$19760.00

Three-pole 600 Volts—Non-Fusible, 316 Stainless Steel

Ampere Rating	Enclosure Type	System Voltage	Product Number	List Price GO-131
30A	NEMA Type 4/4X	600Vac	THN3361SS316 ⁴	\$1932.00
60A	NEMA Type 4/4X	600Vac	THN3362SS316 ⁴	\$2296.00
100A	NEMA Type 4/4X	600Vac	THN3363SS316 ⁴	\$4686.00
200A	NEMA Type 4/4X	600Vac	THN3364SS316 ⁴	\$6167.00
400A	NEMA Type 4/4X	600Vac	THN3365SS316	\$12458.00
600A	NEMA Type 4/4X	600Vac	THN3366SS316	\$17231.00

Viewing Window Option—Factory Installed Only

UL Listed Installation-Safety Switch Rating NEMA Type 4/4X, 5, 12 Standard Lead Time-3 Weeks

Factory Installed Product Number	Suffix for Water and Dust Tight NEMA Type 4/4X	List Price GO-131	Suffix for Drip and Dust Tight NEMA Type 5, 12	List Price GO-131
TH2221	SSW	\$1260.00	JW	\$370.00
TH2222	SSW	\$1499.00	JW	\$469.00
TH3221	SSW	\$1302.00	JW	\$396.00
TH3222	SSW	\$1429.00	JW	\$499.00
TH3223	SSW	\$3291.00	JW	\$756.00
TH3224	SSW	\$4482.00	JW	\$1137.00
TH3321	SSW	\$1322.00	JW	\$440.00
TH3322	SSW	\$1615.00	JW	\$590.00
TH3361	SSW	\$1610.00	JW	\$642.00
TH3362	SSW	\$1764.00	JW	\$657.00
TH3363	SSW	\$3439.00	JW	\$972.00
TH3364	SSW ⁵	\$4785.00	JW ⁵	\$1512.00
TH4321	SSW	\$1381.00	JW	\$483.00
TH4322	SSW	\$1668.00	JW	\$622.00
TH4323	SSW	\$3457.00	JW	\$958.00
TH4324	SSW	\$4811.00	JW	\$1341.00
THN3361	SSW	\$1366.00	JW	\$473.00
THN3362	SSW	\$1610.00	JW	\$564.00
THN3363	SSW	\$3200.00	JW	\$780.00
THN3364	SSW	\$5158.00	JW	\$1011.00

¹2-pole device

²Not CSA Certified

³Use four poles of six-pole switch. Reference page 2-20 for additional information.

⁴Available with "-BA" suffix for ARRA compliance. Same list price and GO schedule. Contact GE Sales Office for other ARRA compliant safety switches.

⁵Rated to maximum 100,000 amperes interrupting capacity.



Safety Switches Mill Duty, Type TH

Spec-Setter™ Safety Switches

30-600 Amperes

240, 480, 600 Volts AC

250, 600 Volts DC

Page Updated 12 / 2011

Section 2

Cartridge Fuse, Type TH Switches

- Designed for mill, foundry and industrial applications where safety, high performance and continuity of service are required.
- UL Listed. Products in this section have been tested by UL and shown to meet the construction and performance requirements of UL Standard Number 98, Enclosed and Dead Front Switches.
- Meet Federal Specification WS-865C for heavy duty switches.
- Meet major automotive manufacturer's and JIC electrical specifications.
- Meet NEMA Enclosed Safety Switch Standard KS1 for Type HD.
- Full cover interlocks.
- 60°C and 75°C conductor ratings.
- Quick-make, quick-break mechanisms.
- Suitable for use as service entrance equipment when installed in accordance with the National Electrical Code.
- UL Listed ratings for fusible switches when used with these fuses:
 - Class H (10,000 rms amps, sym IC). Standard on 30-600 amp.
 - Class J (200,000 rms amp, sym IC). See page 2-28 for field conversion details.
 - Class R (200,000 rms amp, sym IC). Order appropriate Class R fusing kit from page 2-28.
- Safety switch product numbers with suffix "SS" are grade 304 stainless steel.

Type TH Interrupting and Withstandability Ratings

Ampere Rating	Interrupting Rating Amps ¹	
	Symmetrical 600 volts AC, 3-phase	
30A	360	50
60A	1200	200
100A	1200	500
200A	3,400	2,000
400A	10,000	6,000
600A	10,000	12,000

¹Maximum current at rated voltage that switch will interrupt three times without assistance from an external device.

²Peak let-through energy for withstandability and circuit closing tests.



Two-pole, 240 Volts AC - 250 Volts DC, Fusible

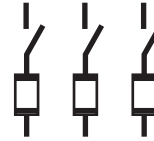

Three-pole, 240 Volts AC, Fusible



Fusible, Two-pole, 240 Volts AC; 250 Volts DC and Two-pole, 600 Volts DC, Fusible (2 poles in series for 600 Vdc)

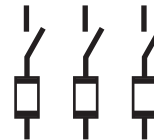

Three-pole, 480 and 600 Volts AC - 250 Volts DC Fusible

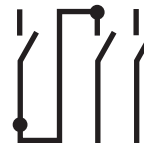

Two-pole, 600 Volts DC, No Fuse



Three-pole, 480 and 600 Volts AC - 250 Volts DC, No Fuse



Safety Switches Mill Duty, Type TH

Spec-Setter™ Safety Switches

300-600 Amperes

240, 480, 600 Volts AC

250, 600 Volts DC

Section 2

Page Updated 09 / 2011

Two-pole, 240 Volts AC - 250 Volts DC, Fusible

Ampere Rating	Enclosure Type ¹	HP, 240 Vac, NEC Std, 1-ph	HP, 240 Vac, NEC Std, 3-ph	HP, 240 Vac, Time Delay, 1-ph	HP, 240 Vac, Time Delay, 3-ph	HP, 125 Vdc	HP, 250 Vdc	HP, 600 Vdc	Product Number	List Price GO-131B
30A	NEMA Type 12	1 1/2	-	3	-	-	5	-	TH2221M	\$324.00
60A	NEMA Type 12	3	-	10	-	5	10	-	TH2222M	\$437.00
100A	NEMA Type 12	7 1/2	-	15	-	-	20	-	TH2223M	\$647.00
200A	NEMA Type 12	15	-	-	-	-	40	-	TH2224M	\$1085.00
30A	NEMA Type 4/4X	1 1/2	-	3	-	-	5	-	TH2221MSS	\$1349.00
60A	NEMA Type 4/4X	3	-	10	-	5	10	-	TH2222MSS	\$1630.00
100A	NEMA Type 4/4X	7 1/2	-	15	-	-	20	-	TH2223MSS	\$3573.00
200A	NEMA Type 4/4X	15	-	-	-	-	40	-	TH2224MSS	\$4914.00

Three-pole, 240 Volts AC, Fusible

Ampere Rating	Enclosure Type ¹	HP, 240 Vac, NEC Std, 1-ph	HP, 240 Vac, NEC Std, 3-ph	HP, 240 Vac, Time Delay, 1-ph	HP, 240 Vac, Time Delay, 3-ph	HP, 125 Vdc	HP, 250 Vdc	HP, 600 Vdc	Product Number	List Price GO-131B
30A	NEMA Type 12	1 1/2	3	3	7 1/2	-	5	-	TH3321M	\$393.00
60A	NEMA Type 12	3	7 1/2	10	15	5	10	-	TH3322M ²	\$566.00
100A	NEMA Type 12	7 1/2	15	15	30	-	20	-	TH3323M	\$875.00
200A	NEMA Type 12	15	25	-	60	-	40	-	TH3324M	\$1305.00
400A	NEMA Type 12	-	50	-	125	-	50	-	TH3325M	\$2883.00
600A	NEMA Type 12	-	75	-	200	-	50	-	TH3326M	\$4804.00
30A	NEMA Type 4/4X	1 1/2	3	3	7 1/2	-	5	-	TH3321MSS	\$1432.00
60A	NEMA Type 4/4X	3	7 1/2	10	15	5	10	-	TH3322MSS	\$1767.00
100A	NEMA Type 4/4X	7 1/2	15	15	30	-	20	-	TH3323MSS	\$3771.00
200A	NEMA Type 4/4X	15	25	-	60	-	40	-	TH3324MSS	\$5305.00
400A	NEMA Type 4/4X	-	50	-	125	-	50	-	TH3325MSS	\$10039.00
600A	NEMA Type 4/4X	-	75	-	200	-	50	-	TH3326MSS	\$14480.00

240 Volts-No Fuse use 600 Volt switches

Two-pole, 600 Volts DC, Fusible

Ampere Rating	Enclosure Type ¹	HP, 480 Vac, NEC Std, 3-ph	HP, 600 Vac, NEC Std, 3-ph	HP, 480 Vac, Time Delay, 3-ph	HP, 600 Vac, Time Delay, 3-ph	HP, 125 Vdc	HP, 250 Vdc	HP, 600 Vdc	Product Number	List Price GO-131B
30A	NEMA Type 12	-	-	-	-	-	-	15	TH2261MDC	\$579.00
60A	NEMA Type 12	-	-	-	-	-	-	25	TH2262MDC	\$600.00
100A	NEMA Type 12	-	-	-	-	-	-	25	TH2263MDC	\$929.00

Three-pole, 480 and 600 Volts AC - 250 Volts DC, Fusible

Ampere Rating	Enclosure Type ¹	HP, 480 Vac, NEC Std, 3-ph	HP, 600 Vac, NEC Std, 3-ph	HP, 480 Vac, Time Delay, 3-ph	HP, 600 Vac, Time Delay, 3-ph	HP, 125 Vdc	HP, 250 Vdc	HP, 600 Vdc	Product Number	List Price GO-131B
30A	NEMA Type 12	5	7 1/2	15	20	-	5	-	TH3361M ²	\$627.00
60A	NEMA Type 12	15	15	30	50	5	10	-	TH3362M	\$647.00
100A	NEMA Type 12	25	30	60	75	-	20	-	TH3363M	\$1006.00
200A	NEMA Type 12	50	60	125	150	-	40	-	TH3364M ³	\$1619.00
400A	NEMA Type 12	100	125	250	350	-	50	-	TH3365M	\$3599.00
600A	NEMA Type 12	150	200	400	500	-	50	-	TH3366M	\$6004.00
30A	NEMA Type 4/4X	5	7 1/2	15	20	-	5	-	TH3361MSS	\$1762.00
60A	NEMA Type 4/4X	15	15	30	50	5	10	-	TH3362MSS ²	\$1941.00
100A	NEMA Type 4/4X	25	30	60	75	-	20	-	TH3363MSS	\$3867.00
200A	NEMA Type 4/4X	50	60	125	150	-	40	-	TH3364MSS ³	\$5417.00
400A	NEMA Type 4/4X	100	125	250	350	-	50	-	TH3365MSS	\$10307.00
600A	NEMA Type 4/4X	150	200	400	500	-	50	-	TH3366MSS	\$14278.00

¹All mill duty switches accept neutral and auxiliary contact kits. Order from page 2-25.

²Available with viewing window - add "W" suffix. Consult Customer Service for price and availability.

³Rated to maximum 100,000 amperes interrupting capacity.



Safety Switches Mill Duty, Type TH

Spec-Setter™ Safety Switches

300-600 Amperes

240, 480, 600 Volts AC

250, 600 Volts DC

Section 2

Page Updated 09 / 2011

Three-pole, 480 and 600 Volts AC – 250 Volts DC Fusible With Viewing Window

Ampere Rating	Enclosure Type ¹	HP, 240 Vac, NEC Std, 1-ph	HP, 240 Vac, NEC Std, 3-ph	HP, 480 Vac, Time Delay, 3-ph	HP, 600 Vac, Time Delay, 3-ph	HP, 125 Vdc	HP, 250 Vdc	HP, 600 Vdc	Product Number	List Price GO-131B
30	NEMA Type 12	5	7 1/2	15	20	–	5	–	THN3361MW	\$654.00

Two-pole, 600 Volts DC, No Fuse

Ampere Rating	Enclosure Type ¹	HP, 240 Vac, NEC Std, 1-ph	HP, 240 Vac, NEC Std, 3-ph	HP, 480 Vac, Time Delay, 3-ph	HP, 600 Vac, Time Delay, 3-ph	HP, 125 Vdc	HP, 250 Vdc	HP, 600 Vdc	Product Number	List Price GO-131B
30A	NEMA Type 12	–	–	–	–	–	–	15	THN2261MDC	\$466.00
60A	NEMA Type 12	–	–	–	–	–	–	25	THN2262MDC	\$483.00
100A	NEMA Type 12	–	–	–	–	–	–	25	THN2263MDC	\$742.00

Three-pole, 480 and 600 Volts AC - 250 Volts DC, No Fuse

Ampere Rating	Enclosure Type ¹	HP, 240 Vac, NEC Std, 1-ph	HP, 240 Vac, NEC Std, 3-ph	HP, 480 Vac, Time Delay, 3-ph	HP, 600 Vac, Time Delay, 3-ph	HP, 125 Vdc	HP, 250 Vdc	HP, 600 Vdc	Product Number	List Price GO-131B
30A	NEMA Type 12	3	10	20	30	3	5	–	THN3361M	\$500.00
60A	NEMA Type 12	10	20	50	60	5	10	–	THN3362M ²	\$517.00
100A	NEMA Type 12	20	40	75	100	–	20	–	THN3363M	\$803.00
200A	NEMA Type 12	30	60	125	150	–	40	–	THN3364M	\$1082.00
400A	NEMA Type 12	–	125	250	350	–	50	–	THN3365M	\$2881.00
600A	NEMA Type 12	–	200	400	500	–	50	–	THN3366M	\$4804.00
30A	NEMA Type 4/4X	3	10	20	30	3	5	–	THN3361MSS ²	\$1482.00
60A	NEMA Type 4/4X	10	20	50	60	5	10	–	THN3362MSS	\$1762.00
100A	NEMA Type 4/4X	20	40	75	100	–	20	–	THN3363MSS	\$3604.00
200A	NEMA Type 4/4X	30	60	125	150	–	40	–	THN3364MSS	\$4917.00
400A	NEMA Type 4/4X	–	125	250	350	–	50	–	THN3365MSS	\$9852.00
600A	NEMA Type 4/4X	–	200	400	500	–	50	–	THN3366MSS	\$13207.00

¹All mill duty switches accept neutral and auxiliary contact kits. Order from page 2-25.

²Available with viewing window – add “W” suffix. Consult Customer Service for price and availability.



Safety Switches

Double-Throw Switches

Page Updated 09 / 2011

Spec-Setter™ Safety Switches
 Type TC, Type TDT
 240, 480, 600 Volts AC
 250 Volts DC

Type TC Non-Fused (NEMA 1) and Outdoor (NEMA 3R) Double-Throw Switches

- Designed for application where safety, high performance, and continuity of service are required.
- UL Listed. Products in this section have been tested by UL and shown to meet the construction and performance requirements of UL Standard Number 98, Enclosed and Dead Front Switches. Suitable for use in accordance with Article 702 of the National Electrical Code.
- Meet Federal Specification W-S-865C for enclosed switches; 30-200 amps, Type HD; 400-600 amps, Type LD.
- Meet or exceed NEMA Enclosed Switch Standard KS1 except paragraph 1-4.24 (withstand and short circuit) for Type HD 30-200 amps, Type GD 400-600 amps.
- 60°C and 75°C conductor ratings.
- Quick-make, quick-break mechanisms 30-200 amps; quick break mechanisms 400-600 amps.
- UL Service Entrance rated (NEMA 1 and NEMA 3R).

Type TC Outdoor Emergency Power Transfer Switches

- Designed for residential or light commercial applications where duty is not severe.
- UL Listed. Products in this section have been tested by UL and shown to meet the construction and performance requirements of UL Standard Number 98, Enclosed and Dead Front Switches.
- Meet or exceed NEMA Enclosed Switch Standard KS1 for Type GD.
- Suitable for use as service entrance equipment when installed in accordance with National Electrical Code.
- 60°C and 75°C conductor ratings.
- Not quick-make, quick-break

Type TDT Fusible Double-Throw Safety Switches

- TDT safety switches are suitable for use as service entrance equipment when either neutral kit DT200NK or ground lug kit DS200GK is installed. UL listed (no CSA or cUL).



TC35322, Type TC Indoor Double-throw Switch



TC35321, Type TC Outdoor Double-throw Switch



TC10323R, Type TC Outdoor Emergency Power Transfer Switch

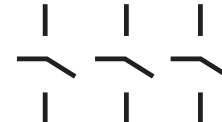

Three-pole, 240 Volts AC, 250 Volts DC, No Fuse



Three-pole, 600 Volts AC, 250 Volts DC, No Fuse



Three-wire SN, 120/240 Volts AC, No Fuse



Four-wire SN, 240 Volts AC, No Fuse



Safety Switches Double-Throw Switches

Section 2

Spec-Setter™ Safety Switches

Type TC, Type TDT

240, 480, 600 Volts AC

250 Volts DC

Three-pole, 240 Volts AC, 250 Volts DC, No Fuse

Ampere Rating	Enclosure Type	HP, 240 Vac, NEC Std, 3-ph	HP, 480 Vac, NEC Std, 3-ph	HP, 600 Vac, NEC Std, 3-ph	Lug Wire Size, AWG/kcmil, Cu Only	Product Number	List Price GO-131B
30A	NEMA Type 1	2	-	-	14-8	TC35321	\$482.00
60A	NEMA Type 1	3	-	-	14-4	TC35322	\$707.00
100A	NEMA Type 1	7 1/2	-	-	14-1/0	TC35323	\$1156.00
200A	NEMA Type 1	15	-	-	6-250	TC35324	\$1825.00
400A	NEMA Type 1	30	-	-	(2)1/0-250 or #2-600	TC35325	\$4967.00
600A	NEMA Type 1	50	-	-	(2)3/0-350 or #2-600	TC35326 ²	\$6665.00

Three-pole, 240 Volts AC, 250 Volts DC, No Fuse

Ampere Rating	Enclosure Type	HP, 240 Vac, NEC Std, 3-ph	HP, 480 Vac, NEC Std, 3-ph	HP, 600 Vac, NEC Std, 3-ph	Lug Wire Size, AWG/kcmil, Cu Only	Product Number	List Price GO-131B
30A	NEMA Type 3R	2	-	-	14-8	TC35321R	\$580.00
60A	NEMA Type 3R	3	-	-	14-4	TC35322R	\$898.00
100A	NEMA Type 3R	7.5	-	-	14-1/0	TC35323R	\$1395.00
200A	NEMA Type 3R	15	-	-	6-250	TC35324R	\$2325.00
400A	NEMA Type 3R	30	-	-	(2) 1/0-250 or #2-600	TC35325R	\$7900.00

Three-pole, 600 Volts AC, 250 Volts DC, No Fuse

Ampere Rating	Enclosure Type	HP, 240 Vac, NEC Std, 3-ph	HP, 480 Vac, NEC Std, 3-ph	HP, 600 Vac, NEC Std, 3-ph	Lug Wire Size, AWG/kcmil, Cu Only	Product Number	List Price GO-131B
30A	NEMA Type 1	10	10	10	14-4	Use 60A	\$810.00
60A	NEMA Type 1	10	10	10	14-4	TC35362	\$810.00
100A	NEMA Type 1	15	15	15	14-1/0	TC35363	\$1281.00
200A	NEMA Type 1	30	30	30	6-250	TC35364	\$1960.00
400A	NEMA Type 1	-	-	-	(2)1/0-250 or #2-600	TC35365 ^{1,2}	\$5063.00
600A	NEMA Type 1	-	-	-	(2)3/0-350 or #2-600	TC35366 ^{1,2}	\$7329.00

Three-pole, 600 Volts AC, 250 Volts DC, No Fuse

Ampere Rating	Enclosure Type	HP, 240 Vac, NEC Std, 3-ph	HP, 480 Vac, NEC Std, 3-ph	HP, 600 Vac, NEC Std, 3-ph	Lug Wire Size, AWG/kcmil, Cu Only	Product Number	List Price GO-131B
30A	NEMA Type 3R	10	10	10	14.4	Use 60A	\$1377.00
60A	NEMA Type 3R	10	10	10	14-4	TC35362R	\$1377.00
100A	NEMA Type 3R	15	15	15	14-1/0	TC35363R	\$2275.00
200A	NEMA Type 3R	30	30	30	6-250	TC35364R	\$4250.00

240 Volts AC, Fusible

Ampere Rating	Enclosure Type	HP, 240 Vac, Time Delay, 1-ph	HP, 480 Vac, Time Delay, 1-ph	HP, 600 Vac, Time Delay, 1-ph	HP, 240 Vac, Time Delay, 3-ph	HP, 480 Vac, Time Delay, 3-ph	HP, 600 Vac, Time Delay, 3-ph	HP, DC @ 250V	Product Number	List Price GO-131B
30A	NEMA Type 1	3	-	-	7 1/2	-	-	5	TDT3321	\$1033.00
60A	NEMA Type 1	10	-	-	15	-	-	10	TDT3322	\$1877.00
100A	NEMA Type 1	15	-	-	30	-	-	20	TDT3323	\$3100.00
200A	NEMA Type 1	15	-	-	60	-	-	40	TDT3324 ³	\$4466.00
400A	NEMA Type 1	-	-	-	125	-	-	50	TDT3325	\$9473.00
600A	NEMA Type 1	-	-	-	50	-	-	50	TDT3326 ⁴	\$11958.00
30A	NEMA Type 3R	3	7 1/2	10	7 1/2	15	20	5	TDT3321R	\$1625.00
60A	NEMA Type 3R	10	20	25	15	30	50	10	TDT3322R	\$2408.00
100A	NEMA Type 3R	15	30	40	30	60	75	20	TDT3323R	\$3242.00
200A	NEMA Type 3R	15	50	50	60	125	150	40	TDT3324R ³	\$5753.00

600 Volts AC, Fusible

Ampere Rating	Enclosure Type	HP, 240 Vac, Time Delay, 1-ph	HP, 480 Vac, Time Delay, 1-ph	HP, 600 Vac, Time Delay, 1-ph	HP, 240 Vac, Time Delay, 3-ph	HP, 480 Vac, Time Delay, 3-ph	HP, 600 Vac, Time Delay, 3-ph	HP, DC @ 250V	Product Number	List Price GO-131B
30A	NEMA Type 1	3	7 1/2	10	7 1/2	15	20	-	TDT3361	\$2088.00
60A	NEMA Type 1	10	20	25	15	30	50	-	TDT3362	\$2103.00
100A	NEMA Type 1	15	30	40	30	60	75	-	TDT3363	\$3708.00
200A	NEMA Type 1	15	50	50	60	125	150	40	TDT3364 ³	\$5492.00
400A	NEMA Type 1	-	-	-	125	250	350	50	TDT3365	\$9704.00
100A	NEMA Type 3R	15	30	40	30	60	75	20	TDT3363R	\$4132.00
200A	NEMA Type 3R	15	50	50	60	125	150	40	TDT3364R ³	\$6141.00

¹Not UL Listed.

²Not suitable for use as service equipment per NEC Article 702.

³200 Amp switches move load base for Class J fuses.

⁴600 Amp switch available with Class T fuse provision only.



Safety Switches Double-Throw Switches

Spec-Setter™ Safety Switches

Type TC Outdoor

240, 480, 600 Volts AC

250 Volts DC

Three-wire SN, 120/240 Volts AC, No Fuse—Emergency Power Transfer Switch

Ampere Rating	Poles	Enclosure Type	Lug Wire Size, AWG/kcmil, Cu/Al	Product Number	List Price GO-131A
100A	2	NEMA Type 3R	12-1	TC10323R	\$501.00
200A	2	NEMA Type 3R	6-250	TC10324R	\$1336.00

Four-wire SN, 240 Volts AC, No Fuse—Emergency Power Transfer Switch

Ampere Rating	Poles	Enclosure Type	Lug Wire Size, AWG/kcmil, Cu/Al	Product Number	List Price GO-131A
200A	3	NEMA Type 3R	6-250	TC10424R	\$1832.00

Accessories for TDT-Style Fusible Double-Throw Safety Switches (Standard Delivery—4 Weeks)

Accessory Type	Description	Product Number	List Price GO-131B
Control Pole	–	DS16CP	\$193.00
Electrical Interlocks	30-800 A, 1N	DS200EK1	\$261.00
Electrical Interlocks	30-800 A, 2N	DS200EK2	\$523.00
Neutral Kit	30-100 A	DT100NK	\$144.00
Neutral Kit	200 A	DT200NK	\$235.00
Neutral Kit	400-600 A	DS800NK	\$564.00
Class J Fuse Field Conversion Kit	400 A (600 V only)	DT400JK	\$499.00
Equipment Ground Kits	30-100 A Kit	DS100GK	\$9.25
Equipment Ground Kits	200 A Kit	DS200GK	\$105.00
Equipment Ground Kits	400-800 A Kit	DS468GK	\$210.00
Class R Fusing Kit—Field Installable	for 3 Poles 30 A (240V)	DS12FK	\$20.25
Class R Fusing Kit—Field Installable	for 3 Poles 30 & 60 A	DS16FK	\$20.25
Class R Fusing Kit—Field Installable	for 3 Poles 60 A (600V)	DS26FK	\$20.25
Class R Fusing Kit—Field Installable	for 3 Poles 100 A (240V & 600V)	DS36FK	\$39.00
Class R Fusing Kit—Field Installable	for 3 Poles 200 A (240V & 600V)	DS46FK	\$57.75
Class R Fusing Kit—Field Installable	for 3 Poles 400 A (240V & 600V)	DS56FK	\$98.00
Class R Fusing Kit—Field Installable	for 3 Poles 600A (240V & 600V)	DS66FK	\$98.00
T Fuse Clip	for 3 Pole 200A (240V)	DS426TK	\$67.50
T Fuse Clip	for 3 Pole 200A (600V)	DS466TK	\$87.50
T Fuse Clip	for 1 Pole 400A (240V)	DS526TK ¹	\$57.50
T Fuse Clip	for 1 Pole 400A (600V)	DS566TK ¹	\$84.50
T Fuse Clip	for 1 Pole 600A (240V)	DS626TK ¹	\$67.50
T Fuse Clip	for 1 Pole 600A (600V)	DS666TK ¹	\$96.00
Conduit Hub—3"	for 200A Type 3R (240V & 600V)	TC300	\$100.00 ²

¹Order one kit per pole.

²GO-131A.

Accessories for 240V & 600V TC Non-Fusible Double Throw Safety Switches

Accessory Type	Switch Amp Rating	Description	Voltage	Product Number	List Price	GO-Schedule
Neutral Kits	30	(5) 1/0-14 with bond strap	240	TNK100	\$60.00	131B
Neutral Kits	60	(5) 1/0-14 with bond strap	240	TNK100	\$60.00	131B
Neutral Kits	100	(5) 1/0-14 with bond strap	240	TNK100	\$60.00	131B
Neutral Kits	200	with bond screw	240	TNK200	\$110.00	131B
Neutral Kits	400	(3) 2-600MCM with bond lug	240	TNK400	\$125.00	131B
Neutral Kits	60	(5) 1/0-14 with bond strap	600	TNK100	\$60.00	131B
Neutral Kits	100	(5) 1/0-14 with bond strap	600	TNK100	\$60.00	131B
Neutral Kits	200	with bond screw	600	TNK200	\$110.00	131B
Ground Kits	30	(4) 14-8 AWG CU or 12-8 AWG AL plus (3) 14-4 AWG CU or 6-4 AWG AL		TGL1	\$12.00	137A
Ground Kits	60	(4) 14-8 AWG CU or 12-8 AWG AL plus (3) 14-4 AWG CU or 6-4 AWG AL		TGL1	\$12.00	137A
Ground Kits	100	(3) #12-1/0 AWG CU/AL		TNG3	\$60.00	137A
Ground Kits	200	(3) #12-1/0 AWG CU/AL		TNG3	\$60.00	137A
Ground Kits	400	(3) #2-250MCM CU/AL		TGL6	\$68.00	131
Ground Kits	600	(3) #2-250MCM CU/AL		TGL6	\$68.00	131
Auxiliary Contact Kit (field installed)	30-600	Auxiliary Contact Kit - Field installed for NEMA 1 and NEMA 3R TC Switches		THAUXDT	\$750.00	131B



Safety Switches

Special Purpose Heavy Duty, Type TH

Spec-Setter™ Safety Switches

Six-pole Switches

- UL Listed. Products in this section have been tested by UL and shown to meet the construction and performance requirements of UL Standard Number 98, Enclosed and Dead Front Switches.
- Single enclosure rated Type 1, 3R and 5/12.
- Drip hood included.
- Furnished without knockouts or hubs. Order hubs separately (see page 2-29).
- Horsepower rated.
- Quick-make, quick-break.
- Full cover interlocks.
- Equipment ground provided.
- Suitable for four-pole applications.
- 60°C and 75°C conductor ratings.

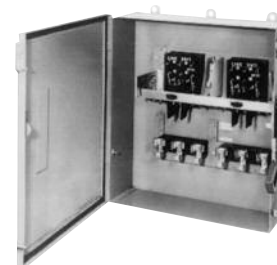

TH6663, Six-pole Switch

Fusing—UL Listed

- Class H (10,000 rms amps, sym IC) standard.
- Class J (200,000 rms amps, sym IC). See page 2-28 for field conversion details.
- Class R (200,000 rms amps, sym IC). Order appropriate Class R fusing kit (2 kits per switch) from table below.

System Voltage	Fusible	Ampere Rating	Product Number	List Price GO-131
240Vac, 250Vdc	Yes	30A	TH6621	\$2303.00
240Vac, 250Vdc	Yes	60A	TH6622	\$2762.00
240Vac, 250Vdc	Yes	100A	TH6623	\$3358.00
240Vac, 250Vdc	Yes	200A	TH6624	\$7555.00
250Vdc, 480Vac, 600Vac	Yes	30A	TH6661	\$2303.00
250Vdc, 480Vac, 600Vac	Yes	60A	TH6662	\$2762.00
250Vdc, 480Vac, 600Vac	Yes	100A	TH6663	\$3358.00
250Vdc, 480Vac, 600Vac	Yes	200A	TH6664	\$7555.00
250Vdc, 480Vac, 600Vac	No	30A	THN6661	\$2048.00
250Vdc, 480Vac, 600Vac	No	60A	THN6662	\$2372.00
250Vdc, 480Vac, 600Vac	No	100A	THN6663	\$2919.00
250Vdc, 480Vac, 600Vac	No	200A	THN6664	\$6564.00

Optional Neutrals

Switch Rating (Amperes)	Switch Rating (Volts)	Product Number	List Price GO-131
30/60	240/600	TNI62	\$35.00
100	240-600	TNI63	\$108.00
200	240-600	TNIJ64	\$132.00

Class R Fuse Kits

Ampere Rating	System Voltage	Product Number	List Price GO-143
30A	240V	TPBRK12A	\$35.00
30A	600V	TPBRK16A	\$35.00
60A	240V	TPBRK22A	\$35.00
60A	600V	TPBRK26A	\$35.00
100A	240Vac-600Vac	TPBRK36A	\$35.00
200A	240Vac-600Vac	TRK46A ¹	\$43.25

¹GO-131



Safety Switches

Special Purpose Heavy Duty, Type TH

Spec-Setter™ Safety Switches

Interlocked Receptacle Switches

- UL Listed. Products in this section have been tested by UL and shown to meet the construction and performance requirements of UL Standard Number 98, Enclosed and Dead Front Switches.
- Meet NEMA Enclosed Safety Switch Standard KS1 for Type HD.
- Type 12 enclosure.
- Furnished without knockouts or hubs. Order hubs separately (see page 2-29).
- Quick-make, quick-break.
- Full cover interlocks.
- 60°C and 75°C conductor ratings.
- Meet horsepower ratings and descriptive data on pages 2-8 through 2-13.

Fusing—UL Listed

- Class H (10,000 rms amps, sym IC) standard.
- Class J (100,000 rms amps, sym IC). See page 2-28 for field conversion details.
- Class R (100,000 rms amps, sym IC). Order appropriate Class R fusing kit from page 2-28.
- Typical application: Portable power supply connection during building construction.
- Interlocked receptacle switches are equipped with 60-amp, three-phase, three-wire grounded type receptacle, prewired and mounted with an interlock linkage to the switch mechanism. The interlock linkage is designed to deter insertion or removal of the plug while the switch is in the “ON” position. It also prevents operation of the switch unless the mating plug is inserted.

Note: Crouse Hinds receptacles use mating plugs that are not supplied with the switch. These can be ordered directly from Crouse Hinds.

Fusible	Receptacle Manufacturer	Mating Plug	Ampere Rating	Product Number	List Price GO-131
Yes	Crouse Hinds	Arktime #APJ6485	60A	TH3362JCH	\$3020.00
No	Crouse Hinds	Arktime #APJ6485	60A	THN3362JCH	\$2843.00

Arktime is a registered trademark of Crouse Hinds Co.



TH3362JCH,
Interlocked Receptacle Switch



Thermoplastic Plug-fuse Type TC Switches

- Designed for residential or light commercial applications where duty is not severe.
- UL Listed. Products in this section have been tested by UL and shown to meet the construction and performance requirements of UL Standard Number 98, Enclosed and Dead Front Switches.
- Meet or exceed NEMA Enclosed Switch Standard KS1 for Type GD.
- 30 ampere maximum.
- Copper wire only, 14-10 AWG.
- GE Valox resin.



TPF130

Enclosure Type	No. of Poles	System Voltage	HP, 240 Vac, NEC Std, 1-ph	HP, 240 Vac, Time Delay, 1-ph	Product Number	List Price GO-131A
NEMA Type 1	1	120Vac	1 1/2	3	TPF130	\$43.25
NEMA Type 1	2	240Vac	1 1/2	3	TPF230	\$59.00

Manual Motor Starters

- UL Listed.
- Toggle operated tumbler.
- Copper wire only, 14-10 AWG.
- No overload protection.
- Standard Package = 50 pcs/carton.

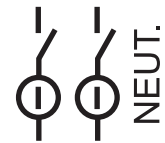

TPF230

No. of Poles	Ampere Rating ¹	System Voltage	HP 110 Vac	HP 240 Vac	HP 480 Vac	HP 600 Vac	Switch Only (no enclosure)		Type 1 Indoor Enclosure	
							Product Number	List Price GO-131B	Product Number	List Price GO-131B
2	30A	240Vac	-	2	2	2	TC2228S	\$57.25	TC2228	\$72.00
	30A	240Vac								
3	20A	480Vac	3	7 1/2	15	15	TC2368S	\$155.00	TC2368	\$172.00
	20A	600Vac								

¹2-Pole manual motor starters do not have a general duty rating at 480 Vac or 600 Vac
 Manual motor starters are not rated for Tungsten or DC lamp loads



TC2368, Manual Motor Starter



Safety Switches

AC Disconnects

Spec-Setter™ Safety Switches

Section 2

Air Conditioner Disconnects

- Puller type
- UL Listed
 - Fusible – UL869
 - Service Equipment
 - No fuse – UL1429
 - Enclosed Pull-out Switch

Enclosure Type ¹	Enclosure Material	Fusible	Ampere Rating	System Voltage	Horsepower Rating	Lug Wire		Standard Package	Product Number	List Price GO-131AC
						Range	AWG Cu/Al			
NEMA Type 3R	Thermoplastic	Yes	30A	120/240Vac	3	14-3	6	TPF30R	\$112.00	
NEMA Type 3R	Thermoplastic	Yes	60A	120/240Vac	10	14-3	6	TPF60R	\$112.00	
NEMA Type 3R	Thermoplastic	No	60A	240Vac	10	14-3	6	TPN60R1	\$96.00	
NEMA Type 3R	Thermoplastic	Non-automatic	60A	240Vac	10	14-3	6	TPNA60R1	\$121.00	
NEMA Type 3R	Steel	Yes	30A	240Vac	3	14-3	6	TF30R	\$102.00	
NEMA Type 3R	Steel	Yes	60A	240Vac	10	14-3	6	TF60R	\$102.00	
NEMA Type 3R	Steel	No	60A	240Vac	10	14-3	6	TFN60R	\$86.00	
NEMA Type 3R	Steel	Non-automatic	60A	240Vac	10	14-3	6	TNA60R1	\$111.00	
NEMA Type 3R	Steel	No	60A	240Vac	10	14-3	6	TFN60RGFR ²	\$300.00	
NEMA Type 3R	Steel	Non-automatic	60A	240Vac	10	14-3	6	TNA60RGFR ²	\$325.00	

¹Devices do not have removable closing cap.
²These AC disconnects include a GFCI outlet.



TPF60R, Air Conditioner Disconnect, Thermoplastic Enclosure



TFN60R, Air Conditioner Disconnect, Steel Enclosure



TNA60RGFR



TFN60RGFR

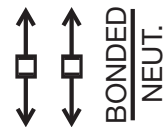

Fusible

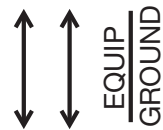

No Fuse



Non-automatic



Safety Switches

Accessories: NEMA Type 1 and 3R Enclosures

Spec-Setter™ Safety Switches
 30-600 Amperes: TG and TH
 800-1200 Amperes: TC

Equipment Ground Kits

Ampere Rating	Wire Range AWG/kcmil Copper	Wire Range AWG/kcmil Aluminum	Standard Package	Product Number	List Price GO-137A
30A	(4) 14-8, (3) 14-4	(4) 14-8, (3) 6-4	20	TGL1	\$12.00
60A					
100A	(3) 10-1/0	(3) 10-1/0	1	TNG3	\$60.00
200A					
600A	(3) 2-250	(3) 2-250	1	TGL6 ¹	\$68.25
400A					

¹GO-131



TGL1 Equipment Ground Kit

Neutral Kit Insulated, Groundable and Bondable

Ampere Rating	System Voltage	Fusible	Wire Range AWG/kcmil Copper	Wire Range AWG/kcmil Aluminum	Standard Package	Product Number	List Price
30A	240Vac					TNI21	\$50.75
30A	600Vac		12-2	12-2	1	TNI62 ²	\$50.75
60A		Yes	12-2	12-2	1	TNIA62	\$50.75
100A		Yes	10-1/0	10-1/0	1	TNIA63	\$108.00
100A		No	10-1/0	10-1/0	1	TNI63 ²	\$108.00
200A			2-250	2-250	1	TNIA64	\$132.00
400A			(1) 2-600 or (2) 1/0-250	(1) 2-600 or (2) 1/0-250	1	TNI65	\$232.00
400A			(1) 350-800	(1) 350-800	1	TNI65A	\$232.00
600A			(2) 4-500	(2) 4-500	1	TNI66	\$232.00
800A			(3) 2-600 or (6) 1/0-250	(3) 2-600 or (6) 1/0-250	1	TNI67	\$490.00
1200A			(4) 3/0-800	(4) 3/0-800	1	TNI68A	\$675.00



TNG3 Equipment Ground Kit

Switching Neutral: Order standard switch of required number of poles and use dummy fuse in neutral pole.

²Not suitable for type TG switches.

Lug Wire Sizes Line and Load Terminals

Ampere Rating	Wire Range AWG/kcmil Copper	Wire Range AWG/kcmil Aluminum
30A (250V)	14-8	12-8
30A (600V)	12-2	12-2
60	12-2	12-2
100	10-1/0	10-1/0
200	2-250	2-250
400	(1) 2-600 or (2) 1/0-250	(1) 2-600 or (2) 1/0-250
600	(2) 4-500	(2) 4-500
800	(3) 2-600 or (6) 1/0-250	(3) 2-600 or (6) 1/0-250
1200	(4) 3/0-800	(4) 3/0-800



Safety Switches

Accessories: NEMA Type 1 and 3R Enclosures

Spec-Setter™ Safety Switches
30-600 Amperes: TH and THN

Auxiliary Contact Kits

- UL Listed for field installation.
- Auxiliary contacts open before switch blades.
- Standard Package = 1.

Series Prefix	Ampere Rating	No. of Poles	Contacts	Contact Ratings	Product Number	List Price GO-131
TH,THN	30A	2	DPDT	10A, 125/250Vac	THAUX21D	\$135.00
		3		0.30A, 125Vdc 0.15A, 250Vdc		
TH,THN	30A	2	SPDT	15A, 600Vac	THAUX61S	\$135.00
		3		0.50A, 125Vdc 0.25A, 250Vdc		
TH,THN	60A 100A 200A	2	DPDT	15A, 600Vac	THAUX64D	\$193.00
		3		0.50A, 125Vdc 0.25A, 250Vdc		
TH,THN	400A 600A	2	DPDT	15A, 600Vac	THAUX66D	\$317.00
		3		0.50A, 125Vdc 0.25A, 250Vdc		
TH,THN	30A 60A 100A	6	DPDT	15A, 600Vac	THAUX66D	\$317.00
				0.50A, 125Vdc		
				0.25A, 250Vdc		
TH,THN	200A	6	DPDT	15A, 600Vac 0.50A, 125Vdc 0.25A, 250Vdc	THAUX66D2	\$317.00

Contact Pilot Duty Ratings - 600 Volt Kits

Volts	Inrush Current		AC	DC (Resistive)	
	N.C.	N.O.	Break Normal Current	Volts	Break Normal Current
115	30	15	15	125	0.5
230	30	15	250	0.25	
460	30	15	15	-	-
575	15	15	2	-	-

Semidust-tight Door Gasket Kits

Types TH Indoor, TG and TH Outdoor Switches. Product Number listed is for field mounted kit.

Ampere Rating	Standard Package	Product Number	List Price GO-131
30A 60A 100A	1	THG106	\$35.50
200A	1	THG107	\$68.25
600A 400A	1	THG108	\$92.00



Safety Switches

Section 2

Accessories: NEMA Type 4/4X, 12 and Mill Duty Enclosures

Spec-Setter™ Safety Switches

30-600 Amperes: TH

Lug Wire Sizes

Line and Load Terminals

Switch Ampere Rating	Factory Installed		Field Installed Crimp Lugs (See Table on page 2-27)	
	Copper	Aluminum	Copper	Aluminum
30A-240V	14-8	12-8	-	-
30A-600V	14-6	14-6	14-8	-
60	14-2	14-2	8-4	-
100	14-1/0	12-1/0	6-1/0	6-2/0
200	6-250	-	1/0-250	-
400	(1) 2-600 or (2) 1/0-250	-	(2) 300-600 or (1) 750	(2) 250-600 or (1) 750
600	(2) 4-600	-	(2) 300-600 or (1) 750	(2) 250-600 or (1) 750

Equipment Ground Terminals—Two lugs supplied per switch, provision for one additional lug.

30	14-6	14-6	14-8	-
60	14-6	14-6	14-8	-
100	14-4	14-4	8	6
200	14-4	14-4	6	4
400	14-1/0	12-1/0	3-2	1
600	14-2/0	14-2/0	1	2/0

Auxiliary Contact Kits

Auxiliary contacts designed to open before switch blades. UL Listed for field installation. Product number listed is for field installed kit.

Series Prefix	Ampere Rating	System Voltage	Standard Package	Contacts	Product Number	List Price GO-131
TH, THN	30A	240V	1	DPDT	THAUX21D	\$135.00
TH, THN	30A	240V	1	SPDT	THAUX61S	\$135.00
TH, THN	30A	600V	1	DPDT	THAUX64D	\$193.00
	60-200A	240-600V				
TH, THN	400-600A	240-600V	1	DPDT	THAUX66D	\$317.00
TC	30-600A	240-600V	2	DPDT	THAUXDT	\$750.00

For Contact Pilot Duty Ratings, see page 2-25.

Optional Copper Lug Neutrals

Ampere Rating	Fusible	Lug Wire Size, AWG/kcmil, Cu Only	Standard Package	Product Number	List Price GO-131
30A-60A	No	14-2	1	TNIJA62CL	\$72.50

Neutral Kit Insulated, Groundable and Bondable

Ampere Rating	System Voltage	Fusible	Lug Wire Size AWG/kcmil Factory Installed Aluminum	Lug Wire Size AWG/kcmil Factory Installed Copper	Lug Wire Size AWG/kcmil Field Installed Crimp Lugs Copper	Lug Wire Size AWG/kcmil Field Installed Crimp Lugs Aluminum	Standard Package	Product Number	List Price GO-131
30A	240Vac	Yes	12-8	14-8	-	-	-	TNI21	\$50.75
30A	600Vac ¹	Yes/No	14-6	14-6	14-8	-	1	TNIJ61	\$50.75
60A	600Vac ²	Yes	14-2	14-2	8-4	-	1	TNIJ62	\$50.75
60A	240Vac ²	Yes	14-2	14-2	8-4	-	1	TNIJ62	\$50.75
60A	600Vac	Yes	14-2	14-2	8-4	-	1	TNIJ62	\$50.75
60A	600Vac ²	No	14-2	14-2	8-4	-	1	TNIJA62	\$50.75
60A	600Vac	No	14-2	14-2	8-4	-	1	TNIJA62	\$50.75
100A	240-600Vac	-	12-1/0	14-1/0	6-1/0	6-2/0	1	TNIJ63	\$108.00
200A	240-600Vac	-	6-250	6-250	1/0-250	1/0-250	1	TNIJ64	\$132.00
400-600A	240-600Vac	-	(2) 4-600	(2) 4-600	(2) 300-600 or (1) 750	(2) 250-600 or (1) 750	1	TNIJ66	\$232.00

¹Type 4, 4x, 12

²Mill duty type



Safety Switches

Section 2

Accessories: NEMA Type 4/4X, 12 and Mill Duty Enclosures

Spec-Setter™ Safety Switches

30-600 Amperes: TH

Crimp-type Connectors - Field Replaceable

(Obtain from normal source. Not furnished with switches.)

Line and Load Terminals

Switch Ampere Rating	Lug Wire Size AWG/kcmil	Thomas and Betts Product Number		Burdny Product Number	
		Copper	Aluminum	Copper	Aluminum
30	14-12	-	-	YAV12 G2	-
30	12-10	-	-	YAV10	-
30	8	54104	-	YAV8C-L	-
60	8	54130	-	YAV8C-L1	-
60	6	54105	-	YAV6C-L	-
60	4	54106	-	YAV4CLY1	-
100	6	54105	60107	-	-
100	4	54106	60112	-	-
100	2	54017	60116	-	-
100	1	54108	60122	-	-
100	1/0	-	-	YA25-L	YA25A1
200	1/0	54153	60129	-	-
200	1/0	54109	60130	-	-
200	2/0	54158	60135	-	-
200	2/0	54110	60136	-	-
200	3/0	54163	60141	-	-
200	3/0	54111	60142	-	-
200	4/0	54168	60147	-	-
200	4/0	54112	60148	-	-
200	250	54173	60153	-	-
200	250	54174	60154	-	-
400 and 600	250	-	60156	-	-
400 and 600	300	54114	60162	-	-
400 and 600	350	54115	60165	-	-
400 and 600	400	54116	-	-	-
400 and 600	500	54118	60171	-	-
400 and 600	600	54120	60174	-	-
400 and 600	750	54123	60178	-	-

Equipment Ground Terminals (provision for three per switch)

30	10	-	-	YAV10	-
30	8	54104	-	-	-
60	8	54104	-	YAV8C-L	-
100	8	54105	-	YAV8C-L	-
100	6	-	60106	-	-
200	6	54105	-	-	-
200	4	-	60112	-	-
400	3-2	54107	-	-	-
400	1	-	60122	-	-
600	1	54108	-	-	-
600	2/0	-	60134	-	-



Class J Fuse Field Conversion Kit UL Listed

TH switches, 30-400 amperes, 600 volt and 100-400 amperes, 240 volt, may be adapted to accept Class J fuses without a kit by moving the load-block toward the switch base and remounting. One kit required per two-pole or three-pole switch.

Series Prefix	Ampere Rating	System Voltage	Product Number	List Price GO-131
TH	600A	240Vac 600Vac	THJ6	\$420.00

Class R Fusing Kit—Field Installable Type TH, UL Listed

When specifications permit only Class R fuses to be used, these kits may be installed in the safety switch to deter fuses other than Class R from being installed. Kits for 30 or 60A switches incorporate replacement fuse clips. Kits for 100-600A switches incorporate rejection pins that assemble to the standard fuse clips.

Enclosure Type	Ampere Rating	System Voltage	Product Number	List Price GO-131
NEMA Type 1, 3R, 4/4X, 12	30A	240Vac	TRK12B	\$17.75
NEMA Type 1, 3R	30A	600Vac	TRK16B	\$17.25
NEMA Type 4/4X, 12	30A	600Vac	TRK16SA	\$17.75
NEMA Type 1, 3R, 4/4X, 12	60A	240Vac	TRK22A	\$17.75
NEMA Type 1, 3R, 4/4X, 12	60A	600Vac	TRK26A	\$17.75
NEMA Type 1, 3R	100A	240Vac 600Vac	TRK46A ¹	\$43.25
NEMA Type 4/4X, 12	100A	240Vac 600Vac	TPBRK36A ²	\$35.00
NEMA Type 1, 3R, 4/4X, 12	200A	240Vac 600Vac	TRK46A	\$43.25
NEMA Type 1, 3R, 4/4X, 12	400A	240Vac 600Vac	TRK56A	\$74.00
NEMA Type 1, 3R, 4/4X, 12	600A	240Vac 600Vac	TRK66A	\$74.00

¹Starting August 2011.

²TPBRK36A is GO-143.



Class R Fuse Kit—Field Installable Type TG, UL Listed

When specifications permit only Class R fuses to be used, these kits may be installed in the safety switch to deter fuses other than Class R from being installed. Kits for 30 or 60A switches incorporate replacement fuse clips. Kits for 100-200A switches incorporate rejection pins that assemble to the standard fuse clips.

Enclosure Type	Ampere Rating	Product Number	List Price GO-131A
NEMA Type 1, 3R	30A	TGRK12	\$17.25
NEMA Type 1, 3R	60A	TGRK22	\$17.25
NEMA Type 1, 3R	100A	TGRK42 ¹	\$74.00
NEMA Type 1, 3R	200A	TGRK42	\$74.00

Universal Raintight Aluminum Hubs

For outdoor enclosures that have removable closing caps.

Nominal Conduit Diameter (in.)	Standard Package	Product Number	List Price GO-131A
3/4	10	TC75	\$24.00
1	10	TC100	\$24.00
1 1/4	10	TC125	\$24.00
1 1/2	10	TC150	\$24.00
2	10	TC200	\$40.25
2 1/2	10	TC250	\$67.75



TC200 Universal Raintight Hub

Closing Cap for Universal Raintight Aluminum Hub

Standard Package	Product Number	List Price GO-131A
10	TCCP	\$2.60

Replacement Red Handle Grip for HD Switches

Product Number	List Price GO-131
THGRIP	\$20.00

¹Starting August 2011.



Safety Switches Enclosure Dimensions

Spec-Setter™ Safety Switches

TG, TH and TS, NEMA Type 1 and 3R Enclosures

Section 2

Page Updated 12 / 2011

NEMA Type 1 TG Approximate Dimensions in Inches Figure 1

Product Number	Dimension W	Dimension H	Dimension D	Dimension W2	KO Figure Number ¹
TG3221	6 1/2	10 5/8	3 5/16	7	1
TG3222	8 1/2	13 7/8	4	9	15
TG3223	9 1/2	21 3/8	5	10	3
TG3224	13 3/4	29 1/4	5 1/2	14	4
TG3225	22	49 1/2	9	23	5
TG3226	23 1/4	50	9 1/4	23 3/4	6
TG3325	22	49 1/2	9	23	7
TG3326	23 1/4	50	9 1/4	23 3/4	6
TG4321	6 1/2	10 5/8	3 5/16	7	1
TG4322	8 1/2	13 7/8	4	9	15
TG4323	9 1/2	21 3/8	5	10	3
TG4324	13 3/4	29 1/4	5 1/2	14	4
TG4325	22	49 1/2	9	23	7
TG4326	23 1/4	50	9 1/4	23 3/4	6
TGN3321	6 1/2	10 5/8	3 5/16	7	1
TGN3322	8 1/2	13 7/8	4	9	15
TGN3323	9 1/2	21 3/8	5	10	3
TGN3324	13 3/4	29 1/4	5 1/2	14	4
TGN3325	22	49 1/2	9	23	7
TGN3326	23 1/4	50	9 1/4	23 3/4	6

¹See page 2-32.

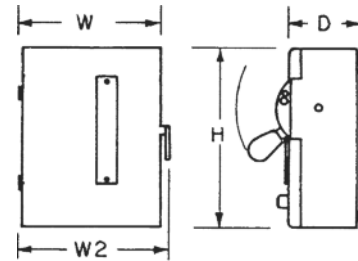

Figure 1

NEMA Type 1 TH Approximate Dimensions in Inches Figure 2

Product Number	Dimension W	Dimension H	Dimension D	Dimension W2	KO Figure Number ¹
TH3221	6 1/2	10 3/8	3 3/8	7 1/8	1
TH3222	9 1/2	17 5/8	5	10 1/8	3
TH3223	9 3/8	19 3/8	5 1/16	10 1/4	3
TH3224	13 1/2	25 3/8	5 1/16	14 1/4	4
TH3225	23 1/5	50 7/8	8 3/8	15 1/4	6
TH3226	24 5/8	59 9/16	8 3/8	25 3/4	6
TH3325	23 1/4	50 7/8	8 3/8	24 1/4	6
TH3326	23 1/4	50 7/8	8 3/8	24 1/4	6
TH4321	6 1/2	10 3/8	3 3/8	7 1/8	1
TH4322	9 1/2	17 5/8	5	10 1/8	3
TH4323	9 1/2	21 3/8	5	10 1/8	3
TH4324	13 5/8	31 5/8	5 1/4	14 1/2	4
TH4325	23 1/4	50 7/8	8 3/8	24 1/4	6
TH4326	23 1/4	50 7/8	8 3/8	24 1/4	6
TH2261DC	8 5/8	12 5/8	4	9 1/2	15
TH2262DC	9 1/2	21 3/8	5	10 1/8	3
TH2263DC	9 1/2	22 3/4	5	10 1/8	14
TH3361	8 5/8	12 5/8	4	9 1/2	15
TH3362	9 1/2	21 3/8	5	10 1/8	3
TH3363	9 1/2	22 3/4	5	10 1/8	14
TH3364	13 5/8	31 5/8	5 1/4	14 1/2	4
TH3365	23 1/4	54	8 3/8	24 1/2	6
TH3366	23 1/4	54	8 3/8	24 1/2	6
THN2261DC	8 1/2	10 9/16	4	9 1/4	15
THN2262DC	9 1/2	17 5/8	5	10 1/8	3
THN2263DC	9 1/2	17 5/8	5	10 1/8	3
THN3321	6 1/2	10 3/8	3 3/8	7 1/8	1
THN3361	8 1/2	10 9/16	4	9 1/4	15
THN3362	9 1/2	17 5/8	5	10 1/8	3
THN3363	9 1/2	17 5/8	5	10 1/8	3
THN3364	13 5/8	31 5/8	5 1/4	14 1/2	4
THN3365	23 1/4	42 1/2	8 3/8	24 1/2	6
THN3366	23 1/4	42 1/2	8 3/8	24 1/2	6

¹See page 2-32.

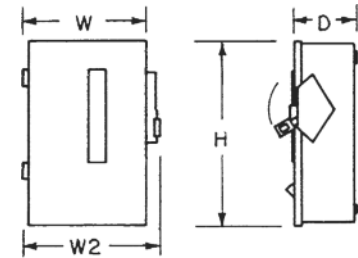

Figure 2



Safety Switches Enclosure Dimensions

Spec-Setter™ Safety Switches
TG, TH and TS, NEMA Type 1 and 3R Enclosures

NEMA Type 3R TG Approximate Dimensions in Inches Figure 3

Product Number	Dimension W	Dimension H	Dimension D	Dimension W2	KO Figure Number ¹
TG3221R	6 7/8	9 7/8	3 5/16	7 1/4	8
TG3222R	8 3/4	13 3/4	4	9 1/4	19
TG3223R	9 7/8	21 1/4	5	10	10
TG3224R	13 3/8	28 3/4	5 1/4	14 1/4	11
TG3225R	22 1/4	49 1/2	9	22 1/2	12
TG3226R	23 5/8	50	9 1/4	23 3/4	13
TG3325R	22 1/4	49 1/2	9	22 1/2	12
TG3326R	23 5/8	50	9 1/4	23 3/4	13
TG4321R	6 7/8	9 7/8	3 5/16	7 1/4	8
TG4322R	8 3/4	13 3/4	4	9 1/4	19
TG4323R	9 7/8	21 1/4	5	10	10
TG4324R	14	29	5 3/8	14 1/4	11
TGN3321R	6 7/8	9 7/8	3 5/16	7 1/4	8
TGN3322R	8 3/4	13 3/4	4	9 1/4	19
TGN3323R	9 1/4	15 1/2	5	10 1/4	10
TGN3324R	13 3/8	28 3/4	5 1/4	14 1/4	11

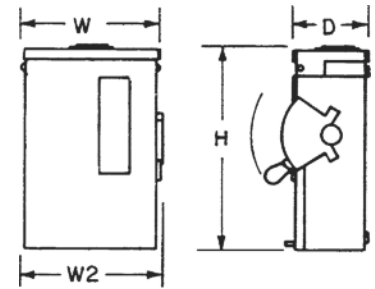

Figure 3

¹See page 2-32.

NEMA Type 3R TH Approximate Dimensions in Inches Figure 4

Product Number	Dimension W	Dimension H	Dimension D	Dimension W2	KO Figure Number ¹
TH3221R	6 7/8	10 5/8	3 5/16	7 1/8	8
TH3222R	9 3/8	19 3/8	5 1/16	10 1/4	10
TH3223R	13 1/2	25 3/8	5 1/16	14 1/4	10
TH3224R	14 1/2	35 1/8	5 5/16	15 1/4	11
TH3225R	24 5/8	59 9/16	8 3/8	25 3/4	18
TH3226R	23 1/2	53 1/4	8 3/8	24 1/4	18
TH3325R	23 1/2	49 1/8	8 3/8	24 1/4	18
TH3326R	23 1/2	53 1/4	8 3/8	24 1/4	18
TH4321R	6 7/8	10 5/8	3 5/16	7 1/8	8
TH4322R	9 7/8	17 1/2	5	10 1/8	10
TH4323R	9 7/8	22 1/4	5	10 5/8	10
TH4324R	14	31 1/2	5 5/16	14 1/8	11
TH2261RDC	8 7/8	13 1/4	4	9 1/2	19
TH2262RDC	9 7/8	22 1/4	5	10 5/8	10
TH2263RDC	9 7/8	22 1/4	5	10 5/8	10
TH3361R	8 7/8	13 1/4	4	9 1/2	19
TH3361RF	10 2/5	15	4 1/8	11 3/10	-
TH3361RF2	13 2/5	22 1/2	5 1/8	14 3/8	-
TH3362R	9 7/8	22 1/4	5	10 5/8	10
TH3362RF	13 2/5	22 1/2	5 1/8	14 3/8	-
TH3363R	9 7/8	22 1/4	5	10 5/8	10
TH3364R	14	31 1/2	5 5/16	14 1/8	11
TH3365R	23 1/2	53 1/4	8 3/8	24 1/4	18
TH3366R	23 1/2	53 1/4	8 3/8	24 1/4	18
THN2261RDC	8 7/8	13 1/4	4	9 1/2	19
THN2262RDC	9 7/8	17 1/2	5	10 1/8	10
THN2263RDC	9 7/8	17 1/2	5	10 1/8	10
THN3361R	8 7/8	13 1/4	4	9 1/2	19
THN3361RF	10 2/5	15	4 1/8	11 3/10	-
THN3362R	9 7/8	17 1/2	5	10 1/8	10
THN3362RF	13 2/5	22 1/2	5 1/8	14 3/8	-
THN3363R	9 7/8	17 1/2	5	10 1/8	10
THN3364R	14	31 1/2	5 5/16	14 1/8	11
THN3365R	23 1/2	49 1/8	8 3/8	24 1/4	18
THN3366R	23 1/2	53 1/4	8 3/8	24 1/4	18

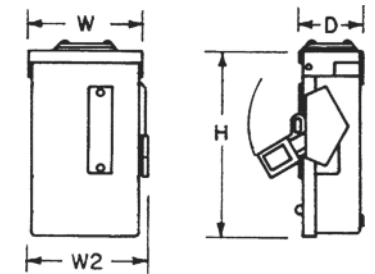

Figure 4

¹See page 2-32.



Safety Switches Knockouts

Spec-Setter™ Safety Switches

TG and TH, NEMA Type 1 and 3R Enclosures

Section 2

Dimensions—Knockouts

Symbol	A	B	C	D	E	F	G	H	J	K	L	M	N
Conduit Size (Inches)	9/32	1/2	1/2	1/2	1/2	1/2	3/4	3/4	1	1	2	2	2 1/2
	—	—	3/4	3/4	3/4	3/4	1	1	1 1/4	1 1/2	2 1/2	2 1/2	3
	—	—	—	1	1	1	—	1 1/4	1 1/2	2	3	3	—
	—	—	—	—	1 1/4	1 1/2	—	1 1/2	2	2 1/2	—	3 1/2	—

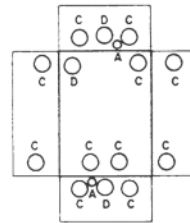

Figure 1

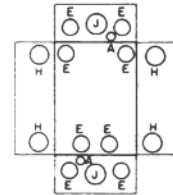

Figure 2

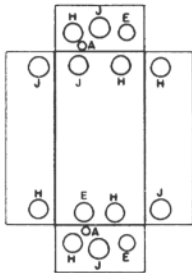

Figure 3

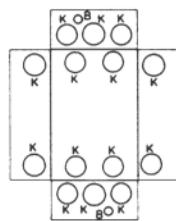

Figure 4

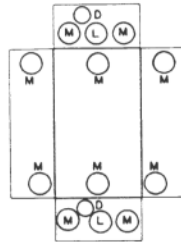

Figure 5

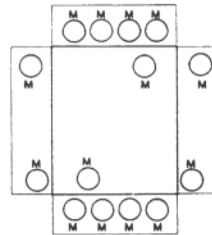

Figure 6

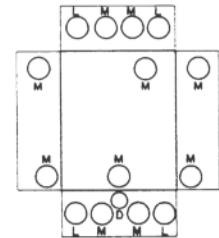

Figure 7

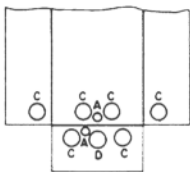

Figure 8

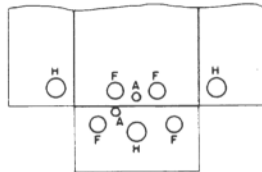

Figure 9

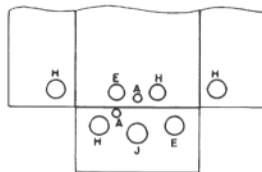

Figure 10

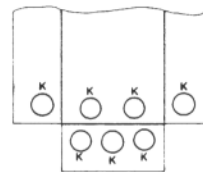

Figure 11

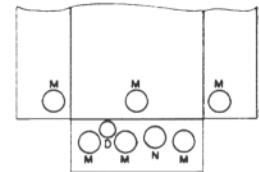

Figure 12

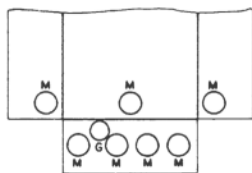

Figure 13

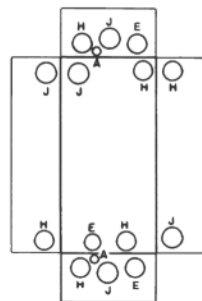

Figure 14

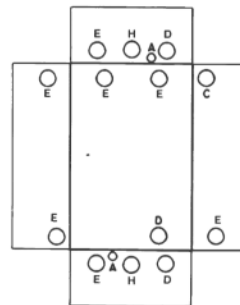

Figure 15

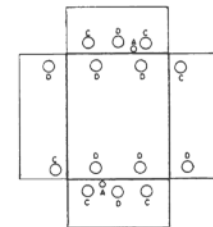

Figure 16

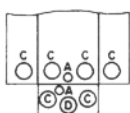

Figure 17

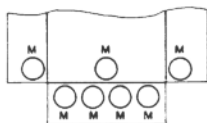

Figure 18

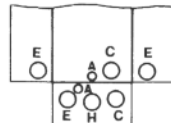

Figure 19



Safety Switches Enclosure Dimensions

Spec-Setter™ Safety Switches
TH NEMA Type 4/4X, 12 and Mill Duty Enclosures

Section 2

NEMA Type 4/4X TH Approximate Dimensions in Inches Figure 1

Product Number	Dimension W	Dimension H	Dimension D	Dimension W2
TH2221SS	7 3/8	11 3/8	5 1/16	8 1/8
TH2222SS	9 3/8	19 3/8	5 1/16	10 1/4
TH2261SSDC	9 3/8	13 3/8	5 5/16	10 1/4
TH2262SSDC	9 3/8	19 3/8	5 5/16	10 1/4
TH2263SSDC	13 1/2	25 3/8	5 5/16	14 1/4
TH3221SS	7 3/8	11 3/8	5 1/16	8 1/8
TH3222SS	9 7/8	17 1/2	5	10 1/8
TH3223SS	9 7/8	22 1/4	5	10 5/8
TH3224SS	14	31 1/2	5 5/16	14 1/8
TH3225SS	23 1/2	49 1/8	8 3/8	24 1/4
TH3226SS	24 5/8	59 9/16	8 3/8	25 3/4
TH3321SS	7 3/8	11 3/8	5 5/16	8 1/8
TH3322SS	9 3/8	19 3/8	5 5/16	10 1/4
TH3361SS	9 3/8	13 3/8	5 5/16	10 1/4
TH3362SS	9 3/8	19 3/8	5 5/16	10 1/4
TH3363SS	13 1/2	25 3/8	5 5/16	14 1/4
TH3364SS	14 1/2	35 1/8	5 5/16	15 1/4
TH3365SS	24 5/8	59 9/16	8 3/8	25 3/4
TH3366SS	24 5/8	59 9/16	8 3/8	25 3/4
TH4321SS	7 3/8	11 3/8	5 1/16	8 1/8
TH4322SS	9 3/8	19 3/8	5 1/16	10 1/4
TH4323SS	13 1/2	25 3/8	5 1/16	14 1/4
TH4324SS	13 1/2	35 1/8	5 5/16	15 1/4
TH4325SS	24 5/8	59 9/16	8 3/8	25 3/4
TH4326SS	24 5/8	59 9/16	8 3/8	25 3/4
THN2261SSDC	9 3/8	13 3/8	5 1/16	10 1/4
THN2262SSDC	9 3/8	19 3/8	5 1/16	10 1/4
THN2263SSDC	13 1/2	25 3/8	5 5/16	14 1/4
THN3361SS	9 3/8	13 3/8	5 1/16	10 1/4
THN3362SS	9 3/8	19 3/8	5 1/16	10 1/4
THN3363SS	13 1/2	25 3/8	5 5/16	14 1/4
THN3364SS	14 1/2	35 1/8	5 5/16	15 1/4
THN3365SS	24 5/8	59 9/16	8 3/8	25 3/4
THN3366SS	24 5/8	59 9/16	8 3/8	25 3/4

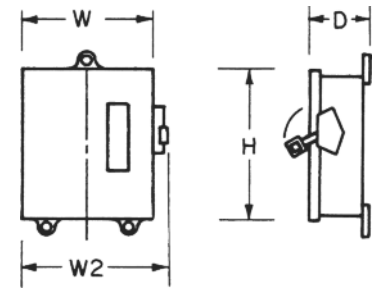

Figure 1

NEMA Type 12 TH Approximate Dimensions in Inches Figure 1

Product Number	Dimension W	Dimension H	Dimension D	Dimension W2
TH2221J	7 3/8	11 3/8	5 1/16	8 1/8
TH2222J	9 3/8	19 3/8	5 1/16	10 1/4
TH2261JDC	9 3/8	13 3/8	5 5/16	10 1/4
TH2262JDC	9 3/8	19 3/8	5 5/16	10 1/4
TH2263JDC	13 1/2	25 3/8	5 5/16	14 1/4
TH3221J	7 3/8	11 3/8	5 1/16	8 1/8
TH3222J	23 1/4	50 7/8	8 3/8	24 1/4
TH3223J	9 1/2	21 3/8	5	10 1/8
TH3224J	13 5/8	31 5/8	5 1/4	14 1/2
TH3225J	23 1/4	50 7/8	8 3/8	24 1/4
TH3226J	24 5/8	59 9/16	8 3/8	25 3/4
TH3321J	7 3/8	11 3/8	5 5/16	8 1/8
TH3322J	9 3/8	19 3/8	5 5/16	10 1/4
TH3361J	9 3/8	13 3/8	5 5/16	10 1/4
TH3362J	9 3/8	19 3/8	5 5/16	10 1/4
TH3363J	13 1/2	25 3/8	5 5/16	14 1/4
TH3364J	14 1/2	35 1/8	5 5/16	15 1/4
TH3365J	24 5/8	59 9/16	8 3/8	25 3/4
TH3366J	24 5/8	59 9/16	8 3/8	25 3/4
TH4321J	7 3/8	11 3/8	5 1/16	8 1/8
TH4322J	9 3/8	19 3/8	5 1/16	10 1/4
TH4323J	13 1/2	25 3/8	5 1/16	14 1/4
TH4324J	13 1/2	35 1/8	5 5/16	15 1/4
TH4325J	24 5/8	59 9/16	8 3/8	25 3/4
TH4326J	24 5/8	59 9/16	8 3/8	25 3/4
THN2261JDC	9 3/8	13 3/8	5 1/16	10 1/4
THN2262JDC	9 3/8	19 3/8	5 1/16	10 1/4
THN2263JDC	13 1/2	25 3/8	5 5/16	14 1/4
THN3361J	9 3/8	13 3/8	5 1/16	10 1/4
THN3362J	9 3/8	19 3/8	5 1/16	10 1/4
THN3363J	13 1/2	25 3/8	5 5/16	14 1/4
THN3364J	14 1/2	35 1/8	5 5/16	15 1/4
THN3365J	24 5/8	48 1/16	8 3/8	25 3/4
THN3366J	24 5/8	48 1/16	8 3/8	25 3/4



Safety Switches Enclosure Dimensions

Spec-Setter™ Safety Switches

TH NEMA Type 4/4X, 12 and Mill Duty Enclosures

Section 2

Mill Duty TH Approximate Dimensions in Inches Figure 1

Product Number	Dimension W	Dimension H	Dimension D	Dimension W2
TH2221M	7 3/8	11 3/8	5 1/16	9 1/4
TH2222M	9 3/8	19 3/8	5 1/16	11 1/4
TH2223M	13 1/2	25 3/8	5 1/16	15 1/4
TH2224M	14 1/2	35 1/8	5 5/16	16 1/4
TH2221MSS	7 3/8	11 3/8	5 1/16	9 1/4
TH2222MSS	9 3/8	19 3/8	5 1/16	11 1/4
TH2223MSS	13 1/2	25 3/8	5 1/16	15 1/4
TH2224MSS	14 1/2	35 1/8	5 5/16	16 1/4
TH2261MDC	9 3/8	19 3/8	5 5/16	11 1/4
TH2262MDC	9 3/8	19 3/8	5 5/16	11 1/4
TH2263MDC	13 1/2	25 3/8	5 5/16	15 1/4
TH2261MSSDC	9 3/8	19 3/8	5 5/16	11 1/4
TH2262MSSDC	9 3/8	19 3/8	5 5/16	11 1/4
TH2263MSSDC	13 1/2	25 3/8	5 5/16	15 1/4
TH3321M	7 3/8	11 3/8	5 1/16	9 1/4
TH3322M	9 3/8	19 3/8	5 1/16	11 1/4
TH3323M	13 1/2	25 3/8	5 1/16	15 1/4
TH3324M	14 1/2	35 1/8	5 5/16	16 1/4
TH3325M	24 5/8	59 9/16	8 3/8	25 3/4
TH3326M	24 5/8	59 9/16	8 3/8	25 3/4
TH3321MSS	7 3/8	11 3/8	5 1/16	9 1/4
TH3322MSS	9 3/8	19 3/8	5 1/16	11 1/4
TH3323MSS	13 1/2	25 3/8	5 1/16	15 1/4
TH3324MSS	14 1/2	35 1/8	5 5/16	16 1/4
TH3325MSS	24 5/8	59 9/16	8 3/8	25 3/4
TH3326MSS	24 5/8	59 9/16	8 3/8	25 3/4
TH3361M	9 3/8	19 3/8	5 5/16	11 1/4
TH3362M	9 3/8	19 3/8	5 5/16	11 1/4
TH3363M	13 1/2	25 3/8	5 5/16	15 1/4
TH3364M	14 1/2	35 1/8	5 5/16	16 1/4
TH3365M	24 5/8	59 9/16	8 3/8	25 3/4
TH3366M	24 5/8	59 9/16	8 3/8	25 3/4
TH3361MSS	9 3/8	19 3/8	5 5/16	11 1/4
TH3362MSS	9 3/8	19 3/8	5 5/16	11 1/4
TH3363MSS	13 1/2	25 3/8	5 5/16	15 1/4
TH3364MSS	14 1/2	35 1/8	5 5/16	16 1/4
TH3365MSS	24 5/8	59 9/16	8 3/8	25 3/4
TH3366MSS	24 5/8	59 9/16	8 3/8	25 3/4
THN2261MDC	9 3/8	13 3/8	5 5/16	11 1/4
THN2262MDC	9 3/8	19 3/8	5 5/16	11 1/4
THN2263MDC	13 1/2	25 3/8	5 5/16	15 1/4
THN2261MSSDC	9 3/8	13 3/8	5 5/16	11 1/4
THN2262MSSDC	9 3/8	19 3/8	5 5/16	11 1/4
THN2263MSSDC	13 1/2	25 3/8	5 5/16	15 1/4
THN3361M	9 3/8	19 3/8	5 5/16	11 1/4
THN3362M	9 3/8	19 3/8	5 5/16	11 1/4
THN3363M	13 1/2	25 3/8	5 5/16	15 1/4
THN3364M	14 1/2	35 1/8	5 5/16	16 1/4
THN3361MSS	9 3/8	19 3/8	5 5/16	11 1/4
THN3362MSS	9 3/8	19 3/8	5 5/16	11 1/4
THN3363MSS	13 1/2	25 3/8	5 5/16	15 1/4
THN3364MSS	14 1/2	35 1/8	5 5/16	16 1/4
THN3365M	24 5/8	48 1/16	8 3/8	25 3/4
THN3365MSS	24 5/8	59 9/16	8 3/8	25 3/4
THN3366M	24 5/8	48 1/16	8 3/8	25 3/4
THN3366MSS	24 5/8	59 9/16	8 3/8	25 3/4

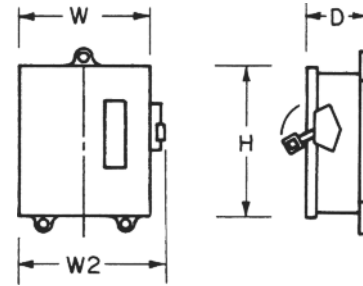

Figure 1



Safety Switches Enclosure Dimensions

Spec-Setter™ Safety Switches
TH NEMA Type 4/4X, 12 and Mill Duty Enclosures

Section 2

Copper Lug THR Approximate Dimensions in Inches Figure 1

Product Number	Dimension W	Dimension H	Dimension D	Dimension W2
THR3361JCL	9 3/8	19 3/8	5 5/16	10 1/4
THR3362JCL	9 3/8	19 3/8	5 5/16	10 1/4
THR3363JCL	13 1/2	25 3/8	5 5/16	14 1/4
THR3364JCL	14 1/2	35 1/8	5 5/16	15 1/4
THR3365JCL	24 5/8	59 9/16	8 3/8	25 3/4
THR3366JCL	24 5/8	59 9/16	8 3/8	25 3/4
THN3361JCL	9 3/8	19 3/8	5 5/16	10 1/4
THN3362JCL	9 3/8	19 3/8	5 5/16	10 1/4
THN3363JCL	13 1/2	25 3/8	5 5/16	14 1/4
THN3364JCL	14 1/2	35 1/8	5 5/16	15 1/4
THN3365JCL	24 5/8	48 1/16	8 3/8	25 3/4
THN3366JCL	24 5/8	48 1/16	8 3/8	25 3/4

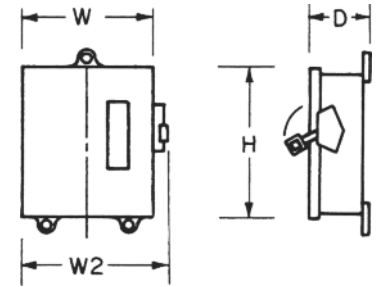

Figure 1

6-pole TH Approximate Dimensions in Inches Figure 1

Product Number	Dimension W	Dimension H	Dimension D	Dimension W2
TH6621	19	14 5/8	6	19 3/4
TH6622	19	24 1/8	6	19 3/4
TH6623	19	24 1/8	6	19 3/4
TH6624	26 1/4	35 3/8	6	27
TH6661	19	14 5/8	6	19 3/4
TH6662	19	24 1/8	6	19 3/4
TH6663	19	24 1/8	6	19 3/4
TH6664	26 1/4	35 3/8	6	27
THN6661	19	14 5/8	6	19 3/4
THN6662	19	24 1/8	6	19 3/4
THN6663	19	24 1/8	6	19 3/4
THN6664	26 1/4	35 3/8	6	27

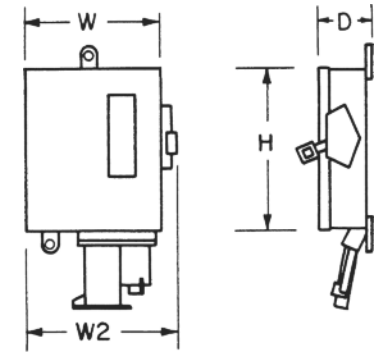

Figure 2

Receptacle TH Approximate Dimensions in Inches Figure 2

Product Number	Dimension W	Dimension H	Dimension D	Dimension W2
TH3362JCH9 3/8	19 3/8	5 5/16	10 1/4	
THN3362JCH	9 3/8	19 3/8	5 5/16	10 1/4



Safety Switches Enclosure Dimensions

Spec-Setter™ Safety Switches
TC, TDT, TPF and TPN
NEMA Type 1 and 3R Enclosures

Section 2

NEMA Type 1 TC Plug Fuse Approximate Dimensions in Inches Figure 1

Product Number	Dimension W	Dimension H	Dimension D	Dimension W2	KO Figure Number ¹
TPF130	4 3/8	7 5/8	2 1/2	4 3/8	17
TPF230	4 3/8	7 5/8	2 1/2	4 3/8	17

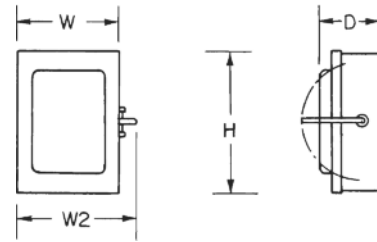

Figure 1

NEMA Type 1 TC Double Throw Approximate Dimensions in Inches Figure 1

Product Number	Dimension W	Dimension H	Dimension D	Dimension W2	KO Figure Number ¹
TC35321	10.37	15.81	5.33	12.04	7
TC35322	11.37	18.75	6.43	13.10	7
TC35323	14.37	22.37	8.06	16.12	9
TC35324	17.87	30.12	9.15	19.88	10
TC35325	24.40	34.31	10.52	26.94	10
TC35326	23.50	44.38	9.25	26.00	12
TC35362	11.37	18.75	6.43	13.10	7
TC35363	14.37	22.37	8.06	16.12	9
TC35364	17.87	30.12	9.15	19.88	10
TC35365	20.44	34.31	8.25	22.90	10
TC35366	23.50	44.38	9.25	26.00	12

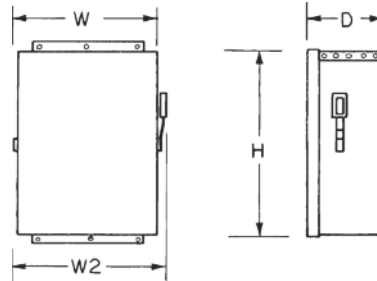

Figure 2

NEMA Type 3R TC Double Throw Approximate Dimensions in Inches Figure 1

Product Number	Dimension W	Dimension H	Dimension D	Dimension W2	KO Figure Number ¹
TC35321R	10.88	19.75	5.33	11.98	No KO
TC35322R	11.88	20.80	6.43	12.98	No KO
TC35323R	14.88	22.91	8.06	16.38	No KO
TC35324R	17.87	30.63	9.15	19.88	No KO
TC35325R	24.40	34.83	10.52	26.94	No KO
TC35362R	11.88	20.80	6.43	12.98	No KO
TC35363R	14.88	22.91	8.06	16.38	No KO
TC35364R	17.87	30.63	9.15	19.88	No KO

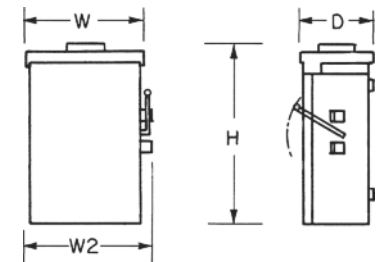

Figure 3

NEMA Type 1 TDT Fusible Double Throw Approximate Dimensions in Inches Figure 5

Product Number	Dimension W	Dimension H	Dimension D	Dimension W2	KO Figure Number ¹
TDT3321	-	37	9 7/8	12 3/4	No KO
TDT3322	-	37	9 7/8	12 3/4	No KO
TDT3323	-	37	9 7/8	12 3/4	No KO
TDT3324	-	51 3/8	11 1/4	20 3/8	No KO
TDT3325	-	74 3/4	14 1/8	26 1/8	No KO
TDT3326	-	86 1/8	14 1/8	28 1/4	No KO
TDT3361	-	37	9 7/8	12 3/4	No KO
TDT3362	-	37	9 7/8	12 3/4	No KO
TDT3363	-	37	9 7/8	12 3/4	No KO
TDT3364	-	51 3/8	11 1/4	20 3/8	No KO
TDT3365	-	74 3/4	14 1/8	26 1/8	No KO

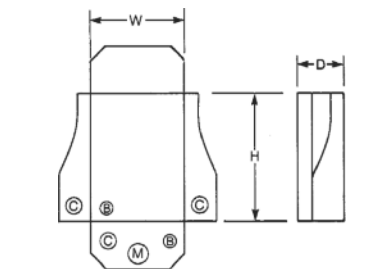

Figure 4

NEMA Type 1 TC 800 and 1200 Amp Approximate Dimensions in Inches Figure 2

Product Number	Dimension W	Dimension H	Dimension D	Dimension W2	KO Figure Number ¹
TC36367	32 1/4	52 1/2	12 1/2	34	No KO
TC36368	37 1/2	65 1/2	13 1/2	39 1/4	No KO
TC72267	41 3/4	62	12 1/2	43 1/2	No KO
TC72268	47 1/2	77	13 1/2	49 1/4	No KO
TC72367	41 3/4	62	12 1/2	43 1/2	No KO
TC72368	47 1/2	77	13 1/2	49 1/4	No KO

NEMA Type 3R TC Double Throw Approximate Dimensions in Inches Figure 3

Product Number	Dimension W	Dimension H	Dimension D	Dimension W2	KO Figure Number ¹
TC10323R	7 3/8	15 1/8	4	8 1/16	15
TC10324R	13 9/16	30	6 1/4	15 5/8	13
TC10424R	13 9/16	30	6 1/4	15 5/8	13

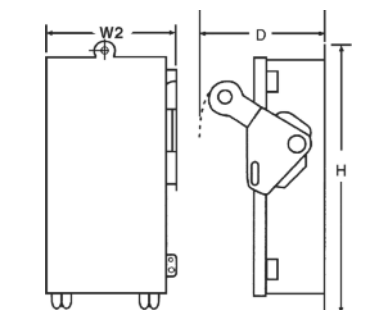

Figure 5

NEMA Type 3R TDT Fusible Double Throw Approximate Dimensions in Inches Figure 5

Product Number	Dimension W	Dimension H	Dimension D	Dimension W2	KO Figure Number ¹
TDT3321R	-	37	9 7/8	12 3/4	No KO
TDT3322R	-	37	9 7/8	12 3/4	No KO
TDT3323R	-	37	9 7/8	12 3/4	No KO
TDT3324R	-	51 3/8	11 1/4	20 3/8	No KO
TDT3363R	-	37	9 7/8	12 3/4	No KO
TDT3364R	-	51 3/8	11 1/4	20 3/8	No KO

¹See page 2-38.



Safety Switches Enclosure Dimensions

Spec-Setter™ Safety Switches

TC, TDT, TPF and TPN

NEMA Type 1 and 3R Enclosures

Section 2

NEMA Type 3R TC 800 and 1200 Amp Approximate Dimensions in Inches Figure 2

Product Number	Dimension W	Dimension H	Dimension D	Dimension W2	KO Figure Number
TC72267R	41 3/4	62	12 1/2	43 1/2	No KO
TC72268R	47 1/2	77	13 1/2	49 1/4	No KO
TC72367R	41 3/4	62	12 1/2	43 1/2	No KO
TC72368R	47 1/2	77	13 1/2	49 1/4	No KO

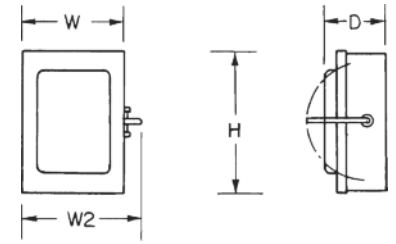

Figure 1

NEMA Type 3R TP AC Disconnect Approximate Dimensions in Inches Figure 4

Product Number	Dimension W	Dimension H	Dimension D	Dimension W2	KO Figure Number ¹
TPF30R	5 3/4	8	3 1/8	-	5
TPF60R	5 3/4	8	3 1/8	-	5
TPN60R1	5	7 1/4	2 1/8	-	5
TPNA60R1	5	7 1/4	2 1/8	-	5

¹See page 2-38.

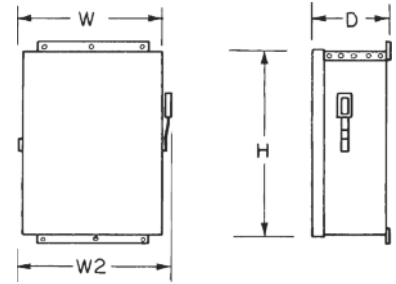

Figure 2

NEMA Type 3R TF AC Disconnect Approximate Dimensions in Inches Figure 5

Product Number	Dimension W	Dimension H	Dimension D	Dimension W2	KO Figure Number ¹
TF30R	4 3/4	7 1/2	2	-	16
TF60R	6 1/2	9	3 1/4	-	16
TFN60R	4 3/4	7 1/2	2	-	16
TFN60RGFR	5 3/4	7 1/8	5 3/16	-	16

¹See page 2-38.

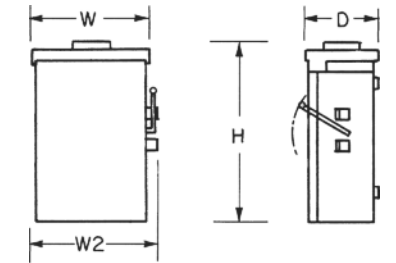

Figure 3

NEMA Type 3R TN AC Disconnect Approximate Dimensions in Inches Figure 5

Product Number	Dimension W	Dimension H	Dimension D	Dimension W2	KO Figure Number ¹
TNA60R1	4 3/4	7 1/2	2	-	16
TNA60RGFR	5 3/4	7 1/8	5 3/16	-	16

¹See page 2-38.

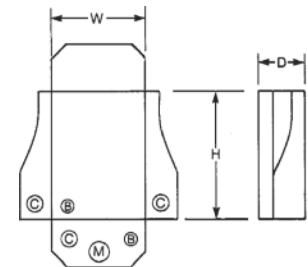

Figure 4

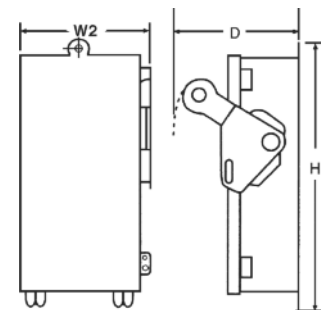

Figure 5



Safety Switches Knockouts

Spec-Setter™ Safety Switches
TC, TDT, TPF and TPN
NEMA Type 1 and 3R Enclosures

Dimensions—Knockouts

Symbol	A	B	C	D	E	F	G	H	J	K	L	M	N
Conduit Size (Inches)	1/2	1/2	3/4	1/2	3/4	1	1 1/4	2	2 1/2	2	3	1	3/4
	—	3/4	1	3/4	1	1 1/4	1 1/2	2 1/2	3	2 1/2	3 1/2	1 1/4	—
	—	—	—	1	1 1/4	1 1/2	2	—	—	3	—	—	—

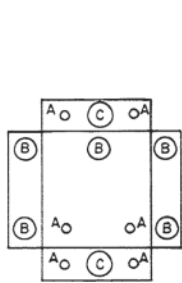

Figure 6

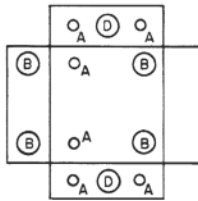

Figure 7

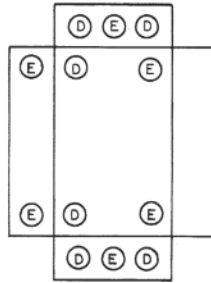

Figure 8

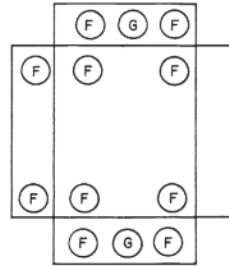

Figure 9

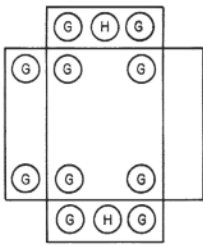

Figure 10

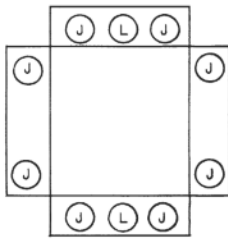

Figure 11

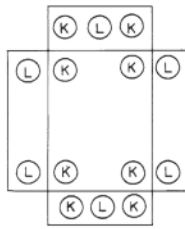

Figure 12

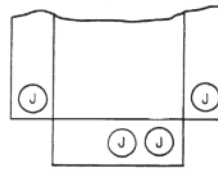

Figure 13

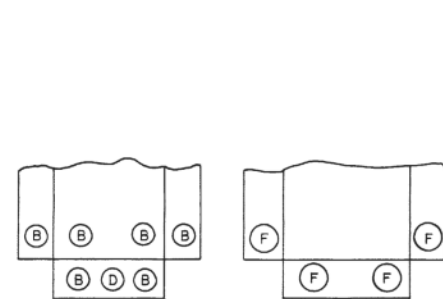

Figure 14

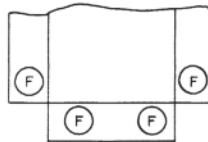

Figure 15

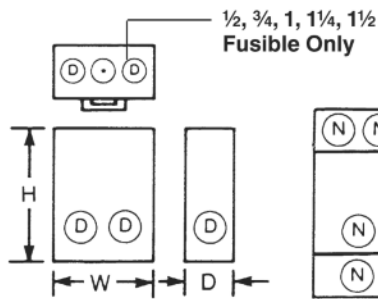

Figure 16



Figure 17



Safety Switches

Low Voltage Construction Fuses

GE Energy Fuse Program in partnership with Ferraz Shawmut

Section 2

Contact your local GE Energy sales representative for fuse applications, specification, and sizing assistance.

600V CLASS J T-D AJT

Features and Benefits

- Solid State SmartSpot Indicator
- Time delay for motor starting and transformer inrush
- 300kA interrupting rating - self-certified, UL witnessed tests
- Low peak let-thru current
- Current limiting UL class fuse
- Small footprint requires less mounting space and allows smaller, more economical fuse blocks
- Easy 2-to-1 selectivity helps prevent nuisance shutdowns
- Unique Class J dimensions help prevent replacement errors
- Metal-embossed date and product number for traceability and lasting identification
- Fiberglass body provides dimensional stability in harsh industrial settings
- High-grade silica filler designed for fast arc quenching
- Optional EI Indicator/Switch mount for AJT70 to 600 open fuse indication

Ratings

- AC: 1 to 600A, 600 Vac, 200kA I.R. (self-certified for 600 Vac, 300kA I.R., UL witnessed)
- DC: 1 to 600A, 500 Vdc, 100kA I.R.



600V CLASS J T-D A4BQ

Features and Benefits

- Faster operation under short circuit conditions: Let-thru currents are typically 20% lower, with a corresponding let-thru energy (clearing I^2t) up to 40% lower than the next fastest Class L fuse
- Time delay for high inrush loads such as motors and transformers, without nuisance opening
- 300kA interrupting rating - self-certified, UL witnessed tests
- Extremely current limiting for lower peak let-thru current.
- Pure silver links ensure low let-thru current and longer fuse life
- Easy 2-to-1 selectivity helps prevent nuisance shutdowns and “blackouts”
- Rejection-style design deters replacement errors
- Helps reduce inventory because A4BQ can replace all older types of Class L fuses now in service
- Metal-embossed date and product number for traceability and lasting identification
- Fiberglass body provides dimensional stability in harsh industrial settings
- High-grade silica filler designed for fast arc quenching

Ratings

- AC: 100 to 6000A, 600 Vac, 200kA I.R. (self-certified for 600 Vac, 300kA I.R., UL witnessed) 4-second delay at 500% rating. Note: 100-600A ratings are non-listed
- DC: 601 to 3000A, 600 Vdc, 100kA I.R.



600V CLASS L A4BY

Features and Benefits

- Unique dimensions help prevent replacement by other fuse classes
- Blade stamped product numbers for permanent identification
- Glass melamine body and plated terminals provide superior reliability in harsh environments

Ratings

- AC: 200 to 6,000A
600 Vac, 200kA I.R.
- DC: 200 to 2500A
300 Vdc, 100kA I.R.



SmartSpot, AmpTrap and UltraSafe are trademarks, and Tri-onic is a registered trademark of Ferraz Shawmut.



Safety Switches

Low Voltage Construction Fuses

GE Energy Fuse Program in partnership with Ferraz Shawmut

Section 2

Contact your local GE Energy sales representative for fuse applications, specification, and sizing assistance.

250 and 600V ONE TIME OT and OTS

Features and Benefits

- Easy to read imprint label for quick recognition and replacement
- Low cost

Ratings

- OT
 - AC: 1 to 600A, 250 Vac, 50kA I.R.
 - DC: 1 to 600A, 250 Vdc, 20kA I.R.
- OTN (Canada)
 - AC: 15 to 60A, 250 Vac, 50kA I.R.
- OTS
 - AC: 1 to 600A, 600 Vac, 50kA I.R.
 - DC: 1 to 600A, 300 Vdc, 20kA I.R.



300 and 600V CLASS T A3T and A6T

Features and Benefits

- Low peak let-thru current
- Unique dimensions designed to prevent replacement by other fuse classes
- Blade-stamped product numbers for permanent identification
- Small physical size for greater design flexibility

Ratings

- A3T
 - AC: 1 to 1200A, 300 Vac, 200kA I.R.
 - DC: 1 to 1200A, 160 Vdc, 50kA I.R.
- A6T
 - AC: 1 to 800A, 600 Vac, 200kA I.R.
 - DC: 1 to 800A, 300 Vdc, 100kA I.R.



600V CLASS J F-A A4J

Features and Benefits

- High current limitation for low peak let-thru current
- Unique dimensions designed to prevent replacement by other fuse classes
- Fiberglass body provides dimensional stability in harsh industrial environments
- Easy-to-read imprint label for quick recognition and replacement

Ratings

- AC: 1 to 600A, 600 Vac, 200kA I.R.
- DC: 1 to 600A, 300 Vdc, 20kA I.R.



Safety Switches

Low Voltage Construction Fuses

GE Energy Fuse Program in partnership with Ferraz Shawmut

Contact your local GE Energy sales representative for fuse applications, specification, and sizing assistance.

250 and 600V RK1 T-D A2D and A6D

Features and Benefits

- Solid State SmartSpot Indicator
- Time delay for motor starting and transformer inrush currents without nuisance opening
- 300kA interrupting rating - self-certified, UL witnessed tests
- Low peak let-thru current
- Easy 2-to-1 selectivity helps prevent nuisance shut downs and “black outs”
- Rejection-style design deters replacement errors (when used with recommended fuse blocks)
- Helps reduce inventory by taking the place of RK5, K, and H fuses
- Metal-embossed date and product number for easier traceability and lasting identification
- Fiberglass body provides dimensional stability in harsh industrial settings
- Brass end-caps (blade-style) for cooler operation and superior performance

Ratings

- A2D
 - AC: 1/10 to 600A, 250 Vac, 200kA I.R. (self-certified for 250 Vac, 300kA I.R., UL witnessed)
- A6D
 - AC: 1/10 to 600A, 600 Vac, 200kA I.R. (self-certified for 600 Vac, 300kA I.R.)



250 and 600V RK1 F-A A2K and A6K

Features and Benefits

- Rejection style design deters replacement by other fuse classes
- Fiberglass body provides dimensional stability in harsh industrial environments
- Easy-to-read imprint label for quick recognition and replacement
- High degree of current limitation for low peak let-thru current

Ratings

- A2K
 - AC: 1 to 600A, 250 Vac, 200kA I.R.
 - DC: 1 to 600A, 250 Vdc, 200kA I.R.
- A6K
 - AC: 1 to 600A, 600 Vac, 200kA I.R.
 - DC: 1 to 600A, 300 Vdc, 200kA I.R.



250 and 600V RK5 T-D TR-R and TRS-R

Features and Benefits

- Solid State SmartSpot Indicator
- Time delay for motor start-ups and transformer inrush currents without nuisance opening
- Current limiting for low peak let-thru current
- Rejection-style design deters replacement errors (when used with recommended fuse blocks)
- Easy-to-read label for quick recognition and replacement
- Metal-embossed date and product number for traceability and lasting identification
- Fiberglass body provides dimensional stability in harsh industrial settings
- Brass end-caps (blade-style) for cooler operation and superior performance
- High-grade silica filler designed for fast arc quenching and high current limitation

Ratings

- TR
 - AC: 1/10 to 600A, 250 Vac, 200kA I.R.
 - DC: 1/10 to 2 8/10A and 35 to 400A, 250 Vdc, 20kA I.R.; 3 to 30A and 450 to 600A, 160 Vdc, 20kA I.R.
- TRS
 - AC: 1/10 to 600A, 600 Vac, 200kA I.R.
 - DC: 1/10 to 12A, 600 Vdc, 20kA I.R.; 70 to 600A, 600 Vdc, 100kA I.R.; 15 to 60A, 300 Vdc, 20kA I.R.



SmartSpot, AmpTrap and UltraSafe are trademarks, and Tri-onic is a registered trademark of Ferraz Shawmut.



Safety Switches

Low Voltage Construction Fuses

GE Energy Fuse Program in partnership with Ferraz Shawmut

Section 2

Contact your local GE Energy sales representative for fuse applications, specification, and sizing assistance.

250V and 600V FBs

Ratings

- 600 Vac, 30A
- Min. voltage to operate indicator light: 90 Vac [Less than 0.7 mA leakage current at 600V]
- Special Indicator for 24 Vdc, 30A
- Special Indicator for 48 Vdc, 30A
- Withstand rating:
 - Class CC 200kA I.R.
 - Midget Fuse 100kA I.R.



PDBs

Features and Benefits

- Finger-Safe
 - Fully insulated block. Recessed termination screws and wire openings provide IP20 grade protection and qualify as “finger-safe” per IEC 529.
- Compact Modularity
 - Single or multiple pole configurations in the most compact footprint. Allows users to build smaller or higher density panels.
- Snap on DIN Rail Mounting
 - Sizes 1 to 4 feature integral DIN rail adaptors allowing for quick and easy installations on 35mm DIN rail yielding lower installed costs.
- Captive Termination Screws
 - Unique channel design ensures captive metric wire termination screws. Screws can never be lost.
- Available Accessories
 - For multi-pole panel mounting, simply snap in pins for rigid fit. Cap plugs provide the ability to maintain touch safety on unused openings. Circuit identification markers simply snap into blocks to ID circuits. End anchors provide rigid end stops.



Ratings

- Ampere ratings from 175 to 840A
- 600V rated

